

Performance Sealing Products for Hydraulic Fluid Power Equipment

Catalog EPS 5371



Engineered Polymer Systems Division | 1-800-233-3900 | www.parker.com/eps

ENGINEERING YOUR SUCCESS.

Contents

INTRODUCTION	3	SYMMETRIC SEALS	65
Products for Reciprocating		Symmetric Profiles	65
Fluid Power Equipment.....	4	Symmetric Decision Tree.....	66
General Application Guidelines.....	6	FlexiSeal® FBC.....	67
ENGINEERING	8	ROD WIPERS	75
Effects of Lip Geometries.....	10	Rod Wiper Profiles.....	75
Surface Speed.....	13	Rod Wiper Decision Tree.....	76
General Guidelines for Hardware Design.....	15	YD.....	77
Hardware Surface Finish.....	16	J.....	80
Surface Finish FAQs.....	20	AY.....	83
Installation Tools — Piston Seals.....	23	AD.....	87
Installation Tools — Rod Seals.....	24	WEAR RINGS / BEARINGS	91
MATERIALS	26	Wear Ring Profiles	91
Typical Physical Properties.....	27	FAQs.....	92
Chemical Compatibility.....	29	Materials	94
Temperature Limits.....	29	WPT	95
Storage and Handling.....	30	WRT	98
ROD SEALS	31	PDW.....	101
Rod Seal Profiles.....	31	POLYURETHANE O-RINGS and D-RINGS	111
Rod Seal Decision Tree	32	O-Ring and D-Ring Profiles	111
BT	33	568 Resilon® O-Ring.....	112
BD	38	DG Resilon® Polyurethane D-Ring	122
BD with Back-Up Ring	42		
BR	46		
PISTON SEALS	51		
Piston Seal Profiles	51		
Piston Seal Decision Tree	52		
BP	53		
CT	56		
OE	60		



Parker Hannifin is the industry leader for sealing system solutions for the fluid power industry.

Parker Engineered Polymer Systems Division offers equipment manufacturers the most comprehensive selection of fluid power seals for reciprocating hydraulic applications. Our innovative technology and value-added services allow us to engineer your success with leading edge material development, experienced design, high quality manufacturing, and outstanding customer service. Parker is your one source manufacturer and sealing solution partner.

PERFORMANCE PRODUCTS FOR RECIPROCATING FLUID POWER EQUIPMENT

Products contained in this catalog represent an elite collection of advanced profile and engineered material combinations. Our “systems approach” in developing advanced compounds and seal geometries that enhance performance for today’s fluid power equipment is rooted in decades of material development, field experience, and close collaboration with industry-leading equipment manufacturers. Additionally, our design engineering team utilizes computer-aided simulation and analytical tools, including non-linear finite element analysis (FEA), which is used to predict the functional performance characteristics and service life of our products in critical applications.

STANDARD SIZES, AVAILABILITY

Parker sealing product designs conform to conventional glands for a wide range of applications, from industrial machinery to mobile equipment, which has to perform under toughest pressure, temperature and media conditions. Configured part numbers contained in gland dimension tables may be ordered from Parker without necessity of Production Preparation Charge (“PPC”) charge. Minimum order quantities apply and lead times may vary.









TECHNICAL ASSISTANCE

If you need assistance, Parker’s team of experienced application engineers is available for consultation.











Reciprocating Fluid Power Equipment

PRODUCTS MATRIX

Profile	Description	Application (Duty)			Page	
		Hydraulic				
		Light	Med	Heavy		
Rod Seals. Rod seals guard against external leakage and are one of the most vital components of the sealing system.						
BT		Premium non-symmetrical U-cup rod seal with a knife trimmed primary lip and molded secondary lip. Standard material is Resilon® 4300. Metric sizes available.	•	•	•	15
BD		Premium non-symmetrical O-ring energized rod seal with a knife trimmed primary lip and molded secondary lip. Standard material is Resilon® 4300.	•	•	•	20
BD with Back-up		Premium non-symmetrical O-ring energized rod seal with a knife trimmed primary lip and molded secondary lip with positively actuated back-up. Standard material is 5065 with nylon back-up.	•	•	•	24
BR		Premium knife trimmed buffer or secondary seal designed to work with a primary rod seal for heavy duty or zero-leak systems. Standard material is Resilon® 4300.		•	•	28
Piston Seals. From low pressure to extreme hydraulic shock loading, products meet the demands of uni-directional and bi-directional pressure, low friction, easy installation, port passing, and zero-drift scenarios.						
BP		Premium bi-directional rubber energized urethane cap piston seal. Standard material is Resilon® 4304. Metric sizes available.		•	•	35
CT		Four piece capped "T-seal" bi-directional piston seal made from molded rubber energizer, 0401 PTFE cap, and nylon back-ups.			•	38
OE		Bi-directional, rubber energized PTFE cap piston seal for long wear, low friction. Short assembly length requires minimal gland space on the piston. Standard materials are 0401 PTFE, 70A NBR energizer.	•	•		42
Symmetric Seals for Rod or Piston Applications. Symmetric profiles are designed to act as either rod or piston seals, allowing one part number to function in two applications						
FBC		Symmetric spring-energized PTFE FlexiSeal. Chamfered ID and OD lip configuration provides concentrated sealing force for maximum sealability. Standard materials are 0100 or 0502 PTFE jacket with medium load, stainless steel cantilever spring.	•	•		49

Reciprocating Fluid Power Equipment

PRODUCTS MATRIX (Cont'd)

Profile	Description	Application (Duty)			Page	
		Hydraulic				
		Light	Med	Heavy		
Wipers. Wipers work in conjunction with rod seals to form the first line of defense in protecting a system and keeping it free from dirt, mud, water, and other contaminants.						
YD		Premium snap-in wiper with OD exclusion lip and a knife trimmed wiping lip. Standard material is Resilon® 4300		.	.	59
J		Standard single-lip, press in place, metal canned wiper with a knife trimmed lip for medium and heavy duty hydraulics. Standard material is 4700.			.	62
AY		Premium snap-in place double-lip wiper for hydraulic applications. Standard material is Resilon® 4300. Metric sizes available.	.	.	.	65
AD		Double acting, double-lip, rubber energized PTFE wiper. Standard PTFE material is 0401.	.	.		69
Wear Rings / Bearings. Tight tolerance wear rings allow for a more precise fit of components, resulting in less dimensional play. Permit use of smaller extrusion gaps – that extend the seal's pressure rating versus standard tolerance.						
WPT		Tight tolerance piston wear ring with chamfered corners. Standard material is 4788.	.	.	.	77
WRT		Tight tolerance rod wear ring with chamfered corners. Standard material is 4788.	.	.	.	80
PDW		Precision cut wear ring/bearing machined from PTFE billet material. Rod and piston chamfer may apply. Standard material is 0307 PTFE.	.	.		83
Resilon® Polyurethane O-Rings, D-Ring. High temperature Resilon polyurethane O-rings and D-rings can eliminate the need for back-ups, simplify installation, and reduce damage due to spiral failure.						
568		High performance polyurethane o-ring made from the Resilon® family of high temperature, low compression set urethanes. Standard material is Resilon® 4300.	.	.	.	94
DG		One-piece hydraulic valve sealing solution designed to replace O-ring and back-ups in dynamic applications. Standard material is Resilon® 4300.	.	.	.	104

General Application Guidelines

Parker's selection of products is the broadest offering in the industry for hydraulic sealing systems. The table below provides "General Application Guidelines" to help define possible differences between light, medium and heavy duty applications. The product profile matrix charts on previous pages show corresponding application duty recommendations for each profile.

IMPORTANT NOTE: It is not uncommon for the requirements of a sealing system to fall into multiple duty columns. When this situation occurs you should select the majority of your components from the higher range.

GENERAL APPLICATION GUIDELINES

Application Parameter	Hydraulic		
	Light Duty	Medium Duty	Heavy Duty
Pressure Range	< 1200 psi (<83 bars)	<3500 psi (<241 bars)	>3500 psi (>241 bars)
Pressure Spikes	None or low	Not to exceed twice the system pressure. Short duration such as valve shifting.	Pressure spikes that may be several times the system pressure and of a longer duration. These are often mechanically induced by forcing the rod in or out.
Temperature Range	0°F to +160°F (-18°C to +71°C)	-20°F to +200°F (-29°C to +93°C)	-45°F to +225°F (-43°C to +107°C)
Contamination	Low or non-existent.	Moderate with cylinder in horizontal or inverted position.	Moderate to high with the cylinder upright — vertical.
Side Loading	None to light with shorter stroke and vertical cylinder mount.	Moderate side load with cylinder mounted towards the vertical position. Medium stroke.	Longer stroke lengths. Cylinder mounted horizontal, heavy side loading.

ADDITIONAL CONSIDERATIONS:

- When selecting a wiper, focus on contamination section.
- In selecting a sealing component you will evaluate the temperature, pressure and pressure spike variables of the application.
- With a wear ring, you will want to look at the temperature and side loading section on page 74. This does not preclude the need to consider such things as fluid being sealed and stroke speed.

General Application Guidelines

Care is taken in the preparation of this publication; however Parker shall not be responsible for a user's reliance on any inadvertent typographical errors or omissions. Information in this catalog is only accurate as of the date of publication. We reserve the right to modify and update information at any time.

WARNING — USER RESPONSIBILITY

This document and other information from Parker Hannifin Corporation, its subsidiaries and authorized distributors provide product or system options for further investigation by users having technical expertise.

The user, through its own analysis and testing, is solely responsible for making the final selection of the system and components and assuring that all performance, endurance, maintenance, safety and warning requirements of the application are met. The user must analyze all aspects of the application, follow applicable industry standards, and follow the information concerning the product in the current product catalog and in any materials provided by Parker or its subsidiaries or authorized distributors.

To the extent that Parker or its subsidiaries or authorized distributors provide component or system options based upon data or specifications provided by the user, the user is responsible for determining that such data and specifications are suitable and sufficient for all applications and responsibly foreseeable uses of the components or systems.

RANGE OF APPLICATION

Our seals may only be used within the application parameters stated in our documents as regards compatibility with contact media, pressures, temperatures and time of storage. Application or use outside of the specified application parameters as well as the selection of different compounds by mistake may result in damage to life, the environment and/or equipment and facilities.

The information contained in our publications is based on know-how developed over decades of experience in the manufacturing and application of seals. Despite this experience, unknown factors arising out of the practical application of seals may considerably affect the overall applicability of this information in such a way that the recommendations provided herein are not to be considered generally binding.

The data for operating pressure, operating temperature, and surface speed stated in the columns represent maximum values and are interrelated. Under extreme working conditions it is recommended not to use all maximum values simultaneously.

For special requirements (pressure, temperature, speed, etc.) please contact our consultancy service, so that suitable materials and/or designs can be recommended.

COMPATIBILITY OF SEALS AND OPERATING MEDIA / CLEANING AGENTS

Due to the great diversity of operational parameters affecting fluidic devices and their impact on seals, it is absolutely imperative that manufacturers of these devices approve seals for functional and operational suitability under field conditions.

Furthermore, in view of the consistent increase of newly available media used as hydraulic oils, lubricants, and cleaning agents, special attention is invited to the aspect of compatibility with sealing elastomers currently in use.

Additives contained in base media in order to enhance certain functional characteristics may affect compatibility characteristics of sealing materials.

For this reason, it is imperative that any product equipped with our seals be tested for compatibility with operational media or cleaning agents approved or specified by you either at your plant or by means of field tests prior to any field use.

We kindly ask you to comply with this notice since, as a manufacturer of seals, we are not in a position, as a matter of principle, to perform simulations of any and all conditions present in the final application nor of knowing the composition of the operational media and cleaning agents used.

DESIGN MODIFICATIONS

We reserve the right to make design modifications without prior notification.

DELIVERY AND SERVICES

For the production of smaller quantities, special compounds, and in case of special production procedures, we reserve the right of charging a production preparation charge at our discretion.

All acceptance, deliveries, and services are subject to our terms.

QUALITY SYSTEMS

Our manufacturing sites are certified according to ISO 9001 and/or ISO/TS 16949.

COPYRIGHT

All rights reserved by Parker Hannifin Corporation. Extracts may only be taken with permission. Modification rights reserved.



ENGINEERING

Contents

Sealing Theory..... 2-1

 Static vs. Dynamic Sealing..... 2-1

 Leakage Control 2-2

 Lip vs. Squeeze Seals..... 2-2

 Effects of Lip Geometries..... 2-3

 Friction 2-3

 Pressure Effects and
 Extrusion..... 2-4

 Seal Wear..... 2-5

 Seal Stability 2-6

 Surface Speed 2-6

 Compression Set 2-7

 Influence of Temperature 2-7

General Guidelines for
Hardware Design 2-8

Hardware Surface Finish..... 2-9

 Surface Finish Guidelines
 for Reciprocating Seals 2-11

 Surface Finish FAQs..... 2-13

Installation

 Considerations 2-14

 Installation Tools – Piston 2-16

 Installation Tools – Rod 2-17

Finite Element Analysis 2-18

Parker Fluid Power Seals for All Application Technologies

Seals have been used since ancient times and have evolved into a wide variety of shapes and materials. For those who are not familiar with sealing technology, the number of options available can be confusing. Selecting the most suitable product for a given application can be difficult. This engineering section will assist in product selection by explaining the fundamentals of seal design and material technology.

Sealing Theory

Static vs. Dynamic Sealing

Every seal, whether static or dynamic, must seal against at least two contacting surfaces. In static applications, both surfaces are non-moving relative to one another. In dynamic applications at least one surface is in motion relative to the other sealing surface(s). For example, in a standard hydraulic cylinder, the rod and piston seals would be classified as dynamic seals, while the seal between the bore and the head gland would be considered a static seal.

In both static and dynamic applications, a certain amount of squeeze or compression is required upon installation to maintain contact with the sealing surfaces and prevent fluid leakage. Dynamic applications in particular involve other variables and require that additional factors be evaluated to ensure proper system performance. These variables are discussed in this section.

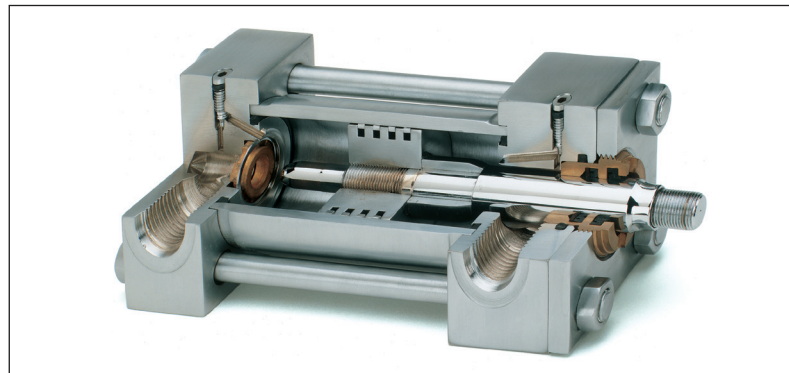

Fig. 2-1. Hydraulic cylinder

Leakage Control

When choosing a sealing system, the desired result is ultimately leakage control. Seal design and material improvements have made it possible not only to have seal combinations that provide zero leakage, but also provide extended life in a variety of applications. Aside from the seals themselves, a thorough understanding of system parameters is necessary to obtain the best results.

Optimal sealing is best achieved by taking a systems approach to the seal package rather than considering components individually. Our profiles have been designed specifically to complement one another to create high performance systems. For example, pairing a Parker rod seal with a Parker wiper minimizes fluid leakage and maximizes contamination exclusion. Our rod seals are designed with knife-trimmed lips to ensure the best possible film breaking. This dry rod technology permits the wiper to be extremely aggressive, excluding contamination without building up oil leakage around the wiper. Another systems approach to effectively control leakage is to incorporate multiple sealing lips. Parker's BR buffer ring, BT u-cup and AH double-lip canned wiper are designed to work together to give optimized performance and the driest sealing available in the industry (see Figure 2-2).

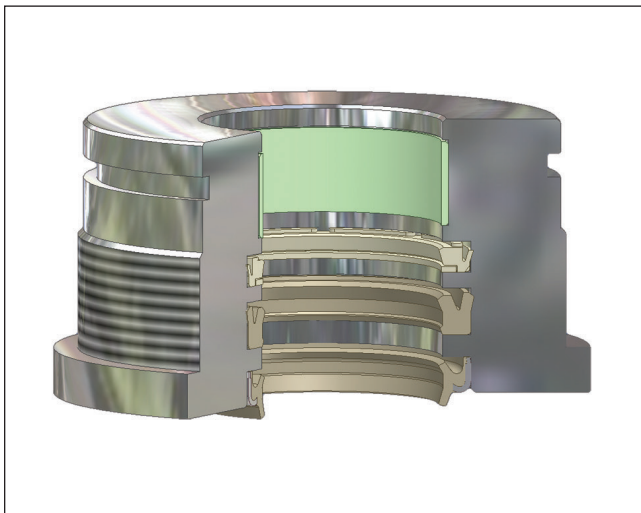

Figure 2-2. BR, BT, AH sealing system for leakage control

Even when appropriate seals are specified, it is still possible to experience leakage due to factors extending beyond the seals themselves. Examples are hardware considerations like surface finish, installation damage, seal storage, chemical wash downs, maintenance and contamination. Adhering to the design recommendations found herein not only for seals, but also for the mating hardware will

provide the greatest likelihood of minimized leakage.

Lip vs. Squeeze Seals

The cross-sectional shape of a seal dramatically affects how it functions, especially at low pressure. The greatest trade-off in dynamic sealing is low friction performance vs. low pressure sealability. At low pressure, friction, wear and sealing ability are affected by whether or not the seal is a lip or squeeze profile (see Figure 2-3). With this in mind, seals are often categorized as either "lip seals" or "squeeze seals," and many fall somewhere in between. Lip seals are characterized by low friction and low wear; however, they also exhibit poor low pressure sealability. Squeeze seals are characterized by just

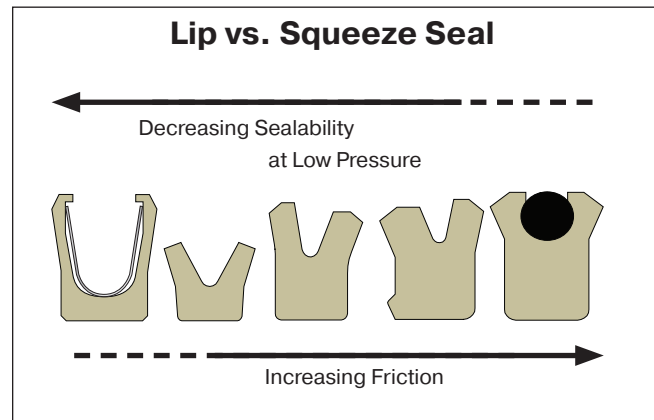

Figure 2-3. Lip seal vs. squeeze seal

the opposite: high friction and high wear, but better low pressure sealability.

As described above, a squeeze type seal will generate much more sealing force than a lip type seal. The assumption here is that both seals are under zero or low pressure. However, as fluid pressure increases, the differences between seal types become insignificant due to the force from the fluid pressure overcoming the designed squeeze. Pressure generally improves leakage control, but increases friction and its associated heat, wear and potential for extrusion.

In pneumatic applications, low friction is of the utmost importance. As such, lip seals are an excellent choice for these low pressure applications. Conversely, in hydraulic cylinders, where high system pressures easily overcome frictional forces, squeeze seals are often the appropriate choice. An example of a hydraulic application in which a squeeze seal would not be appropriate is a gravity returned hydraulic ram. In this case, a lip type hydraulic seal would generate lower friction, allowing the gravity return to function properly.

ENGINEERING

Effects of Lip Geometries

Lip geometry will determine several functions of the seal. Force concentration on the shaft, film breaking ability, hydroplaning characteristics and contamination exclusion are all factors dependent on lip shape. Table 2-1 shows four different lip shapes and provides helpful insights for choosing an appropriate lip geometry.

Table 2-1. Seal Lip Contact Shape

Contact Shape	Rounded	Straight Cut	Beveled	Square
Seal Lip Shape Shape of Contact Force/ Stress Profile				
Film Break- ing Ability	Low	High	Very High	Medium
Contam- in-ation Exclusion	Low	Very High	Low	High
Tendency to Hydro- plane	High	Very Low	Low	Medium
Typical Uses	Pneumatic U-cups	Wipers and Piston Seals	Rod Seals	Piston Seals

Friction

Friction is a function of the radial force exerted by the seal and the coefficient of friction between the seal and the dynamic sealing surface. Reducing friction is generally desirable, but not always necessary. Friction is undesirable because of heat

generation, seal wear and reduced system efficiency.

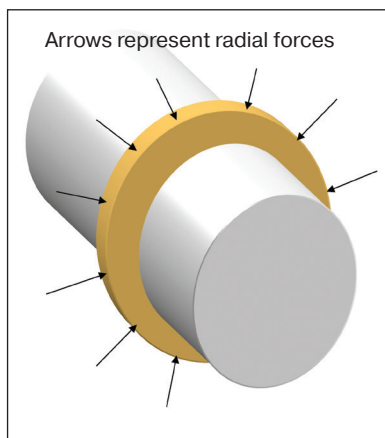

Figure 2-4. Radial force

Factors that affect the radial force are:

- Pressure
- Material modulus
- Temperature
- Lip geometry
- Squeeze vs. lip seal

Factors that affect the coefficient of friction are:

- Seal material
- Dynamic surface roughness
- Temperature
- Lubrication

When the proper seal selection is made, most seals will function such that friction is not a concern. However, when friction becomes critical, there are several ways to reduce it:

- Reduce the lip cross-section
- Decrease lip squeeze
- Change seal material
- Evaluate the hardware's surface finish
- Reduce system pressure
- Improve lubrication

Lowering friction increases seal life by reducing wear, increasing extrusion resistance, decreasing compression set and the rate of chemical attack.

Breakaway friction must be overcome for movement to begin. It is influenced by the duration in which an application remains stationary. The longer the duration, the more lubrication will be forced out from between the seal and the contacting surface. The seal material then conforms to the profile of the surface finish. These events increase breakaway friction.

Stick-slip is characterized by distinct stop-start movement of the cylinder, and may be so rapid that it resembles severe vibration, high pitched noise or chatter. Seals are often thought to be the source of the stick-slip, but other components or hardware can create this issue.

Causes of stick-slip include swelling of wear rings or back-up rings, extreme side-loading, valve pulsation, poor fluid lubricity, external sliding surfaces or seal pressure trapping. This condition can be puzzling or difficult to resolve. Possible causes and trouble-shooting solutions are listed in the following [Table 2-2](#).

Table 2-2. Stick-slip Causes and Troubleshooting Tips

Possible Causes	Troubleshooting Tips
Surface finish out of specification	Verify surface is neither too smooth or too rough
Poor fluid lubricity	Change fluid or use oil treatments or friction reducers
Binding wear rings	Check gland dimensions, check for thermal or chemical swell
Side loading	Review cylinder alignment, incorporate adequate bearing area
Seal friction	Use material with lower coefficient of friction
Cycle speed	Slow movement increases likelihood of stick-slip
Temperature	High temperature softens seals, expands wear rings, and can cause thermal expansion differences within hardware
Valve pulsation	Ensure valves are properly sized and adjusted
External hardware	Review system for harmonic resonance

Pressure Effects and Extrusion

Extrusion occurs when fluid pressure forces the seal material into the clearance gap between mating hardware. Dynamic motion further promotes extrusion, as surfaces in motion tend to pull material into the extrusion gap, generating additional frictional forces and heat. This can cause premature failure via several modes. Extruded seal material can break away and get caught underneath sealing lips, creating leak paths. As material continues to break away, seal geometry erodes, causing instability and eventual leakage. Additionally, heat generated from added friction will cause the seals to take a compression set, dramatically shortening their life.

Careful design considerations should be evaluated to prevent extrusion. For example, minimizing clearance gaps and selecting a proper material based on system temperature, pressure and fluid

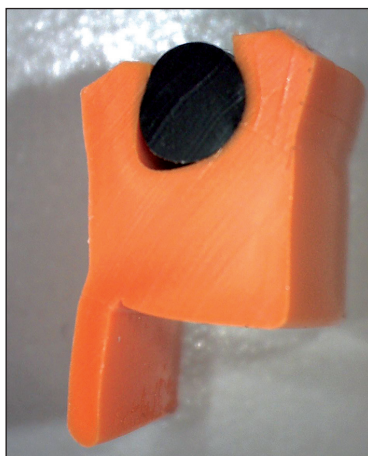

Figure 2-5. Extrusion damage

are both helpful in reducing the risk of extrusion. As clearance gaps increase, less pressure is required in order for extrusion to occur. Higher temperatures can also play a role in this effect by causing seal materials to soften, encouraging extrusion at lower pressures. If the seal material chosen is not suitable to be used in the system fluid, softening due to chemical attack can also decrease its ability to resist extrusion.

The following Table 2-3 lists possible causes of

Table 2-3. Extrusion Causes and Troubleshooting Tips

Possible Causes
Large extrusion gaps
High operating temperature
Soft materials
High system pressure
Pressure spikes
Side loading
Wear rings
Chemical compatibility
Troubleshooting Tips
Reduce extrusion gaps
Check gland dimensions
Replace commercial grade wear rings with tight tolerance wear rings
Incorporate back-up rings
Evaluate size and positioning of wear rings for side load resistance
Consider harder, higher modulus and tensile strength compound
Match seal compound for pressure, temperature and fluid compatibility

extrusion and troubleshooting tips for preventative or corrective measures.

By definition, the radial gap is one-half of the diametrical gap. The actual extrusion gap is often mistaken as the radial gap. This is too optimistic in most cases because side loading of the rod and piston will shift the diametrical clearance to one side. Often, gravity alone is sufficient for this to occur. Good practice is to design around worst case conditions so that extrusion and seal damage do not occur. [Table 2-4](#) provides maximum *radial* extrusion

As a general rule of thumb, the pressure rating of dynamic seals will be approximately one-half that of static seals.

ENGINEERING

Table 2-4. Typical Pressure Ratings for Standard Seal Compounds in Reciprocating Applications at +160°F (see Note)

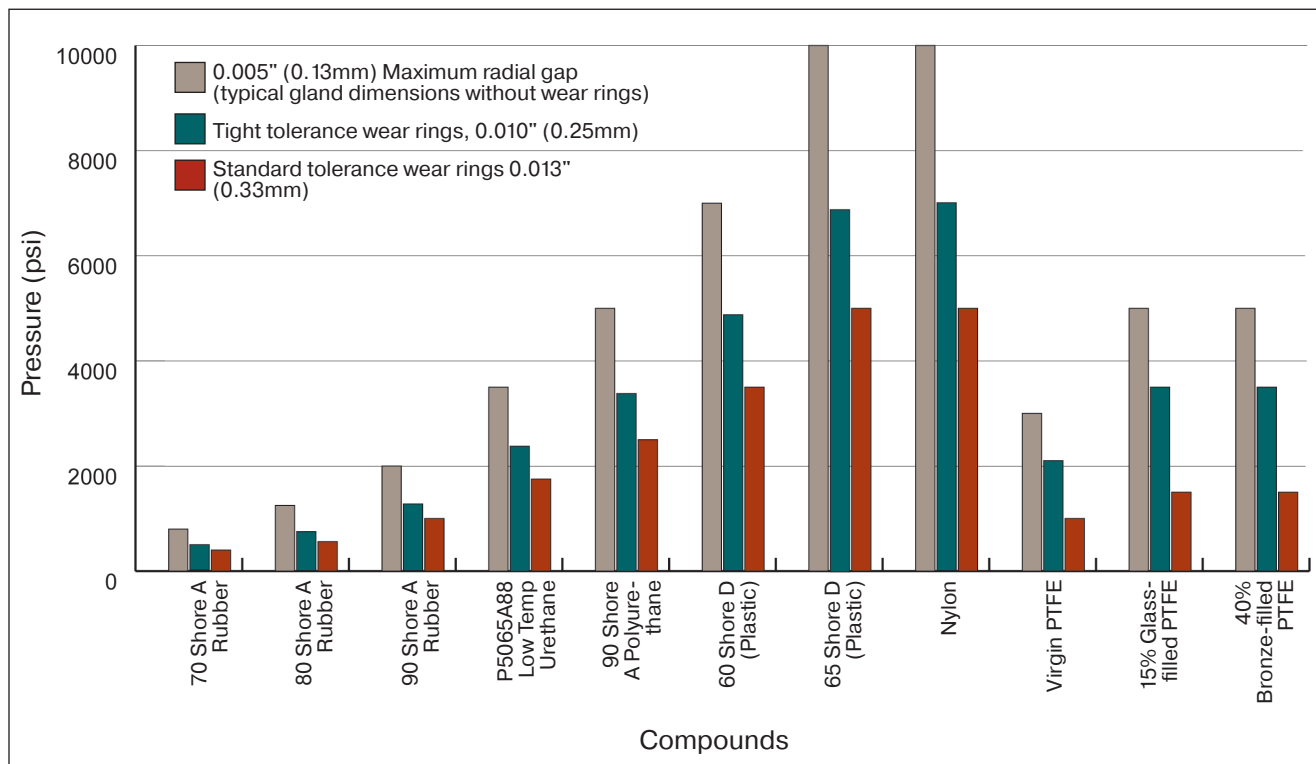

Note: Pressure ratings are based upon a test temperature of +160°F (+70°C). Lower temperatures will increase a material's pressure rating. Higher temperatures will decrease pressure ratings. Maximum radial gap is equal to the diametrical gap when wear rings are not used. Wear rings keep hardware concentric, but increase extrusion gaps to keep metal-to-metal contact from occurring, thereby decreasing pressure ratings when used.

gaps for various seal compounds.

As noted in Table 2-4, pressure ratings decrease when wear rings are used due to the larger extrusion gaps required to eliminate metal-to-metal contact. If wear rings are used, be sure to consult Section 9 (Wear Rings) and Section 10 (Back-ups) for appropriate hardware dimensions. Wear ring hardware dimensions for the piston and rod throat diameters always supersede those dimensions called out for the seals themselves.

Seal Wear

Seals will inevitably wear in dynamic applications, but with appropriate design considerations, this can be minimized. The wear pattern should be even and consistent around the circumference of the dynamic lip. A small amount of even wear will not drastically affect seal performance; however, if the wear patterns are uneven or grooved, or if the amount of wear is excessive, performance may be dramatically reduced. There are many factors that influence seal

Table 2-5. Factors Influencing Seal Wear

Factors that Influence Seal Wear	
Rough surface finish	Excessive abrasion may occur above 12 µin Ra
Ultra smooth surface finish	Surface finishes below 2 µin Ra can create aggressive seal wear due to lack of lubrication
High pressure	Increases the radial force of the seal against the dynamic surface
High temperature	While hot, materials soften, thus reducing tensile strength
Poor fluid lubricity	Increases friction and temperature at sealing contact point
Tensile strength of seal compound	Higher tensile strength increases the material's resistance to tearing and abrading
Fluid incompatibility	Softening of seal compound leads to reduced tensile strength
Coefficient of friction of seal compound	Higher coefficient materials generate higher frictional forces
Abrasive fluid or contamination	Creates grooves in the lip, scores the sealing surface and forms leak paths
Extremely hard sealing surface	Sharp peaks on hard surfaces will not be rounded off during normal contact with the wear rings and seals, accelerating wear conditions



wear, many of which are described in the following Table 2-5.

Seal wear may be indicated by flattening out of the contact point, or, in extreme circumstances, may

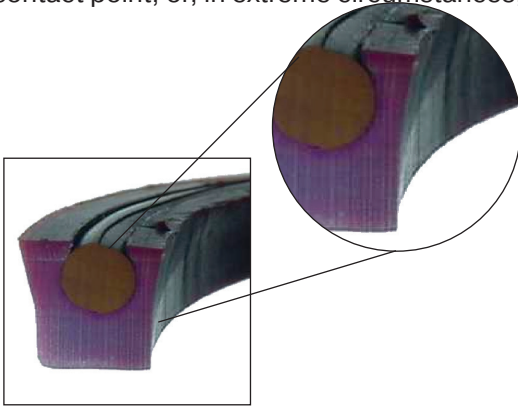

Figure 2-6. Seal wear on dynamic surface

appear along the entire dynamic surface as shown in Figure 2-6.

Seal Stability

Dynamic stability is integral to a seal's performance, allowing the lip to effectively contact the sealing surface, eliminating rocking and pumping effects and promoting an even wear pattern at the sealing contact point. Instability can create leakage and seal damage. A typical instability malfunction known as "spiral failure" can occur when o-rings are used in reciprocating applications. Due to frictional forces that occur while the system is cycling, the o-ring will tend to roll or twist in the groove, causing leakage and even possible breakage. A square geometry will tend to resist this better than a round profile, but is not impervious to instability failure. Rectangular geometries provide the best stability in dynamic applications.

Other less obvious factors that influence the



Fig. 2-7. Instability failure of a square profile piston seal

stability of a seal are:

- Percent gland fill
- Hardness or stiffness of the seal material
- Rough surfaces which create high friction
- Cross-section (larger is better)
- Design features of a seal (i.e. stabilizing lip, non-symmetrical design). Figure 2-8 illustrates how design features can make a seal more stable. In the first FEA plot, the seal is centered in the gland and does not incorporate a stabilizing lip. In the second plot, the seal is loaded against the static gland and includes a stabilizing lip. Stability has been enhanced by the design changes.

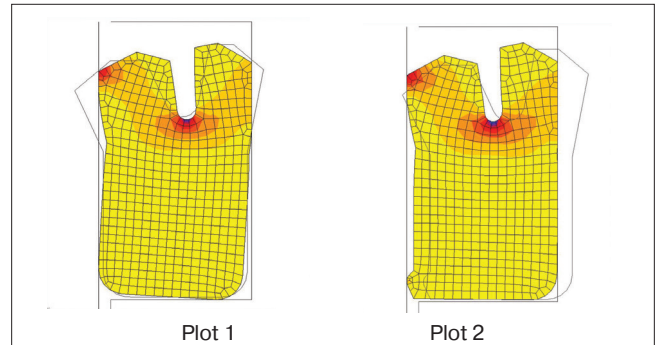

Figure 2-8. Design improvements for increased stability

Surface Speed

The surface speed of a reciprocating shaft can affect the function of a seal. Hydroplaning and frictional heat may occur with excessive speed, while stick-slip, discussed previously in the friction section, is most often associated with slow speed.

Hydroplaning occurs when hydrodynamic forces lift the sealing lip off of the dynamic surface, allowing fluid to bypass the seal. The lip geometry, as well as the overall force on the lip, will influence its ability to resist hydroplaning. Most hydraulic seals are rated for speeds up to 20 inches/second (0.5 m/second), but this may be too fast for certain lip geometries or when the seal has a lightly loaded design. Table 2-1 on page 2-3 shows which lip geometries are subject to hydroplaning. Straight cut and beveled lip geometries are the most effective at resisting hydroplaning so long as sufficient lip loading is present to overcome the hydrodynamic forces.

High surface speeds can create excessive frictional heat. This can create seal problems when the dynamic surface is continuously moving. The under-lip temperature of the seal will become much hotter than the system fluid temperature, especially when the seal is under pressure. If the heat being generated cannot be dissipated, the seal will experience compression set, wear, extrusion and/or increased chemical attack.

ENGINEERING

Compression Set

Compression set is the inability of a seal to return to its original shape after being compressed. As defined by ASTM, it is the percent of deflection by which the seal fails to recover after a specific deflection, time and temperature. Compression set is calculated using the following equation:

$$\text{Compression Set} = \frac{H_i - H_R}{H_i - H_C} \times 100$$

where

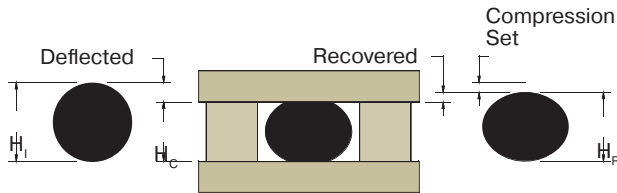

- H_i = Initial height
- H_c = Compressed height
- H_r = Recovered height

Compression set reduces sealing forces, resulting in poor low pressure sealability. It takes place primarily because of excessive exposure to a high temperature. A material's upper end temperature limit may give an indication of its compression set resistance. Although compression set always reduces the seal's dimensions, chemical swell or shrinkage can either positively or negatively impact the final geometry of the seal. If material shrinkage occurs due to the system fluid, the deflection of the seal will decrease, accelerating leakage. If chemical swell is present, it can negate or offset the negative effects of compression set. While it is true that swelling can offset compression set, extreme fluid incompatibility can break down the polymer's chemical structure and cause the material to be reformed in its compressed state

The seal shown in Figure 2-9 exhibits nearly 100% compression set with minimal wear. Note how the lips flare out very little.

Influence of Temperature

Lip wear is also a dimensional loss, but is not related to compression set. Dimensional loss due to lip wear will increase the final compression set value.

All seal materials have a specified operating temperature range (see Section 3, Materials). These temperatures are provided as guidelines and should not be used as specification limits. It is wise practice

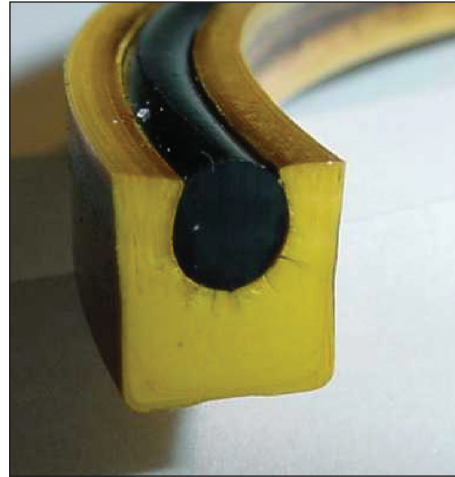

Figure 2-9. Seal exhibiting nearly 100% compression set

to stay well within this range, knowing that physical properties are severely degraded as either limit is approached.

Temperature affects extrusion, wear, chemical resistance and compression set, which ultimately influences the sealing ability of a product. High temperatures reduce abrasion resistance, soften materials, allowing them to extrude at lower pressures, increase compression set and can accelerate chemical attack. Low temperatures can cause materials to shrink and harden, reducing resiliency and sealability. Some of these problems can be solved by using low temperature expanders or metal springs as a component of the seal selection (see Section 3, Materials).

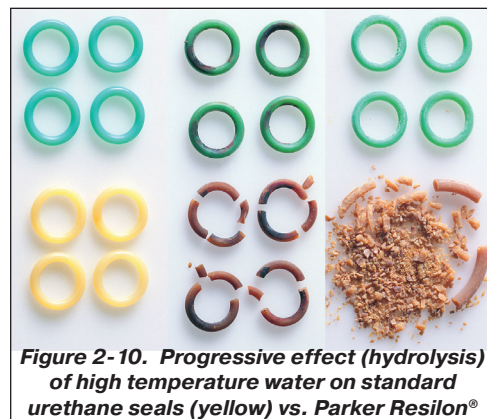

Figure 2-10. Progressive effect (hydrolysis) of high temperature water on standard urethane seals (yellow) vs. Parker Resilon® 4301 polyurethane seals (aqua).



General Guidelines for Hardware Design

For easy assembly and to avoid damage to the seal during assembly, Parker recommends that designers adhere to the tolerances, surface finishes, leading edge chamfers and dimensions shown in this catalog.

Table 2-6.

Installation Chamfer, Gland Radius, and Taper		
Seal Cross Section	"A" Dimension	"R" Dimension
1/16	0.035	0.003
3/32	0.050	0.015
1/8	0.050	0.015
5/32	0.070	0.015
3/16	0.080	0.015
7/32	0.080	0.015
1/4	0.080	0.015
9/32	0.085	0.015
5/16	0.085	0.015
11/32	0.085	0.015
3/8	0.090	0.015
13/32	0.095	0.015
7/16	0.105	0.030
15/32	0.110	0.030
1/2	0.120	0.030
17/32	0.125	0.030

Installation Chamfer, Gland Radius, and Taper		
Seal Cross Section	"A" Dimension	"R" Dimension
9/16	0.130	0.030
19/32	0.135	0.040
5/8	0.145	0.040
21/32	0.150	0.040
11/16	0.160	0.040
23/32	0.165	0.040
3/4	0.170	0.040
25/32	0.180	0.060
13/16	0.185	0.060
27/32	0.190	0.060
7/8	0.200	0.080
29/32	0.205	0.080
15/16	0.215	0.080
31/32	0.220	0.080
1	0.225	0.080

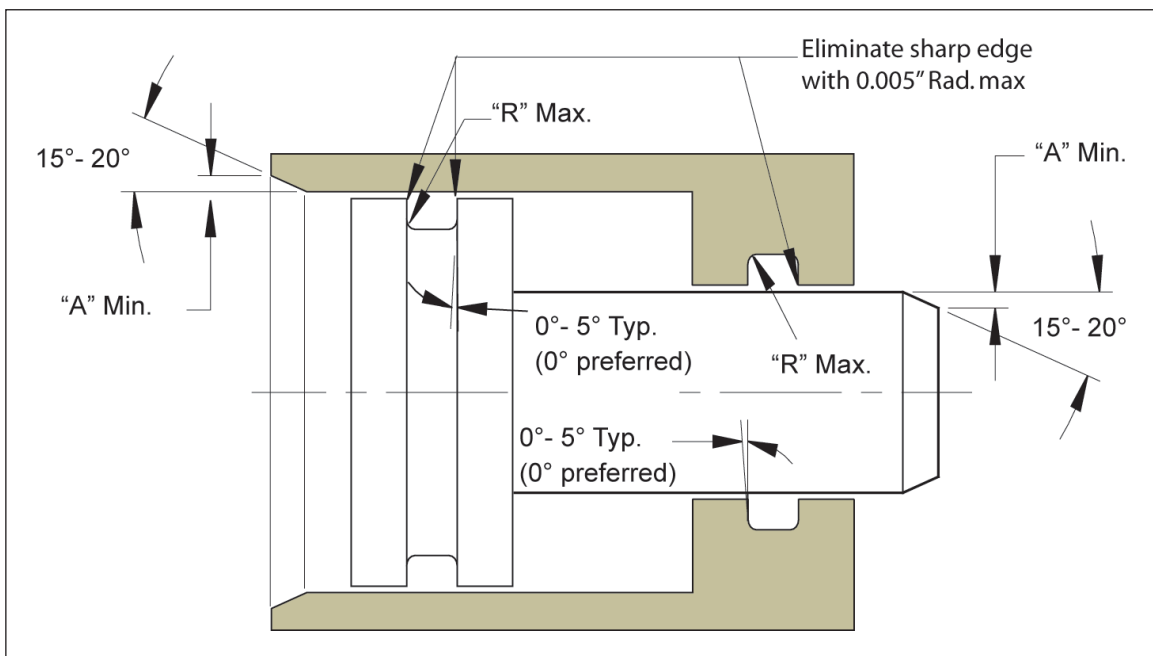

Figure 2-11.

ENGINEERING

Hardware Surface Finish

Understanding and applying the benefits of appropriate surface finish specifications can dramatically affect the longevity of a sealing system. In a dynamic surface, microscopic variations form recesses which hold an oil film between the seal lip and the moving surface. If the surface is too smooth, friction and seal wear will be high because this oil film will not be present. If the surface is too rough, the variations will create leak paths and accelerate lip wear. For these reasons, it is critical to have an in depth understanding of surface finishes as they pertain to dynamic sealing systems. As such, Parker recommends following the guidelines for surface finish as outlined below or conducting individual testing for specific applications to validate seal function and expected life.

Over the years, greater attention has been given to this subject as realizations about warranty savings and system life become more prevalent. As equipment required to measure and maintain a proper surface finish has evolved and improved, the subject of surface finish has become more complex. Traditional visual inspection gauges are no longer sufficient to effectively measure surface finish. Profilometers are now commonly used to achieve precise measurements with repeatable results. In the same way, the terms used to define a surface finish have also advanced.

For many years, a single surface parameter has often been used to quantify surface finish. RMS (also known as Rq) stands for Root Mean Square and has historically been the most typical value. In more recent years, the Arithmetic Average Roughness, Ra, has become more frequently specified. Using either of these parameters by itself is inadequate to define a proper reciprocating sealing surface. Figure 2-12 depicts why this parameter alone cannot accurately describe a surface finish.

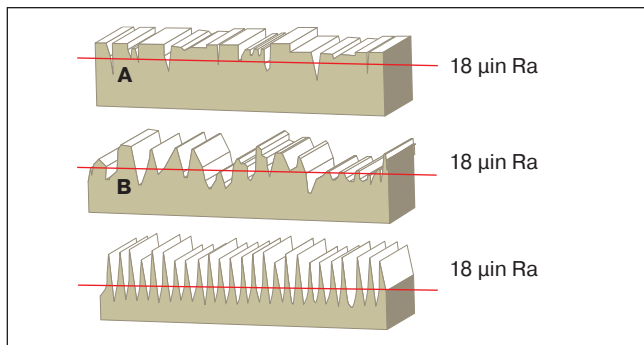

Figure 2-12. Different surface finishes yielding same Ra value

The three surface finishes shown in Figure 2-12 all have the same Ra value but very unique characteristics.

The first profile (A) is an example of a proper surface finish for dynamic seals in which the sharp peaks have been minimized or removed. The second profile (B) will exhibit high wear characteristics because of the wide spacing between the peaks. The third profile (C) will also wear out the seals quickly because of its extremely sharp peaks.

Ra is sufficient to define the magnitude of surface roughness, but is insufficient to define a surface entirely in that it only describes the average deviation from the mean line, not the nature of the peaks and valleys in a profile. To obtain an accurate surface description, parameters such as Rp, Rz and Rmr (tp) can be used to define the relative magnitude of the peaks and the spacing between them. These parameters are defined in Table 2-7, and their combination can identify if a surface is too rough or even too smooth for reciprocating applications.

There are other parameters that can be considered for surface finish evaluation. For example, the limitation of Rt is that it considers only one measurement, while Rz, Rp and Rmr consider the full profile.

RMS = Rq. The Root Mean Square (RMS) as defined by ISO 4287:1997 and other standards is often defined as Rq. These terms are interchangeable.

Rq ≠ Ra. Confusion has typically existed regarding these values, leading to misconceptions that they are interchangeable. Rq and Ra will never be equal on typical surfaces. Another misconception is that there is an approximate 11% difference between the two. Ground and polished surfaces can have Rq values that are 20 to 50 percent higher than Ra. The 11% difference would only occur if the surface being measured took the form of a true sine wave. A series of tests conducted at Parker has shown Rq to be 30% higher than Ra on average.

What's the Significance? Specifications previously based on a maximum surface finish of 16 µin RMS for ground and polished rods should specify a maximum finish of **12 µin Ra**.



Table 2-7. Roughness Parameter Descriptions

Parameter Descriptions

Roughness parameters are defined per ISO 4287:1997 and ISO 4288:1996.

Ra* – Arithmetic average or mean deviation from the center line within a sampling length.

Rq* – Root mean square deviation from the center line within a sampling length.

Rp* – Maximum profile peak height within a sampling length. Also known as Rpm in ASME B46.1 – 2002.

Rv* – Maximum profile valley depth within a sampling length. Also known as Rvm in ASME B46.1 – 2002.

Rz* – Maximum height of profile within a sampling length ($Rz = Rp + Rv$).

NOTE: ISO 4287:1984, which measured five peaks and five valleys within a sampling length, is now obsolete. This value would be much lower because additional shorter peaks and valleys are measured. Over the years there have been several Rz definitions used. Care needs to be taken to identify which is used.

Rt – Maximum height of the profile within the evaluation length. An evaluation length is typically five sampling lengths.

Rmr – Relative material ratio measured at a given height relative to a reference zero line. Indicates the amount of surface contact area at this height. Also known as tp (bearing length ratio) in ASME B46.1 – 2002.

*Parameters are first defined over a sampling length. When multiple sampling lengths are measured, an average value is calculated, resulting in the final value of the parameter. The standard number of sampling lengths per ISO 4287:1997 and ISO 4288:1996 is five.

Figure 2-13 graphically represents Ra. The shaded area, which represents the average height of the profile, Ra, is equal to the area of the hatched portion. The mean line, shown in red, splits the hatched area in half and forms the center line for Ra. The graph also shows Rq, which is higher than Ra.

Figure 2-14 shows the actual surface profile of a polished chrome rod.

Upon examination of the profile, it can be seen that the polishing operation has removed or rounded the peaks producing a positive affect on the characteristics of the sealing surface, as described below by Ra, Rp, Rz and Rmr.

- Ra = 8.9 μ in
- Rp = 14.8 μ in (which is 1.7 x Ra, less than the 3x guideline)
- Rz = 62.9 μ in (which is 7.1 x Ra, less than the 8x guideline)
- Rmr = 74%

Figure 2-14 also illustrates how Rp and Rz are calculated using the following equations:

$$R_p = \frac{R_{p1} + R_{p2} + R_{p3} + R_{p4} + R_{p5}}{5}$$

$$R_z = \frac{R_{z1} + R_{z2} + R_{z3} + R_{z4} + R_{z5}}{5}$$

NOTE: In the profile shown in Figure 2-14, $R_t = R_z2$ because the tallest peak and deepest valley occur in the same sampling length.

Figure 2-15 considers the same surface and illustrates how the Rmr value of 74% is determined. To accomplish this, locate the height of the curve at 5% material area (this is the reference line or “zero line”). From this height, move down a distance of 25% Rz and locate the new intersection point along the curve. This new intersection point is the actual Rmr value of 74%.

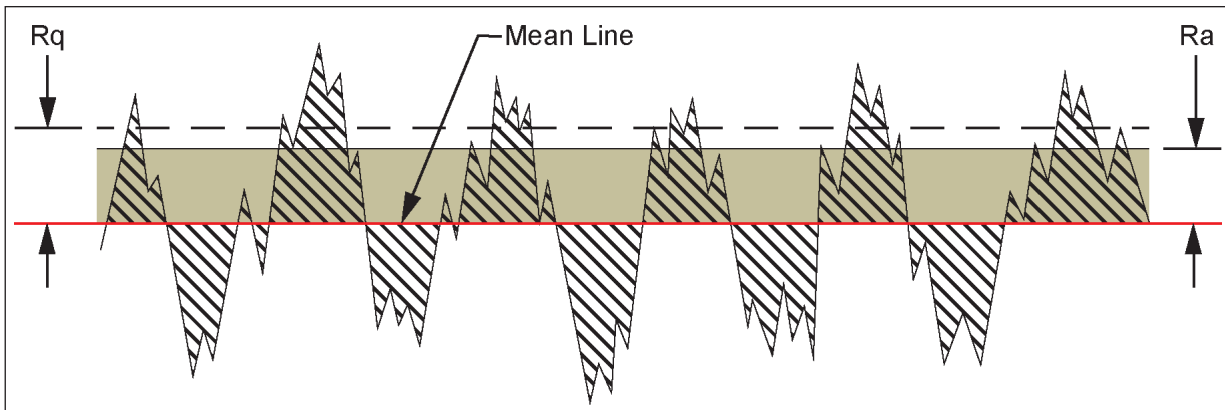

Figure 2-13.

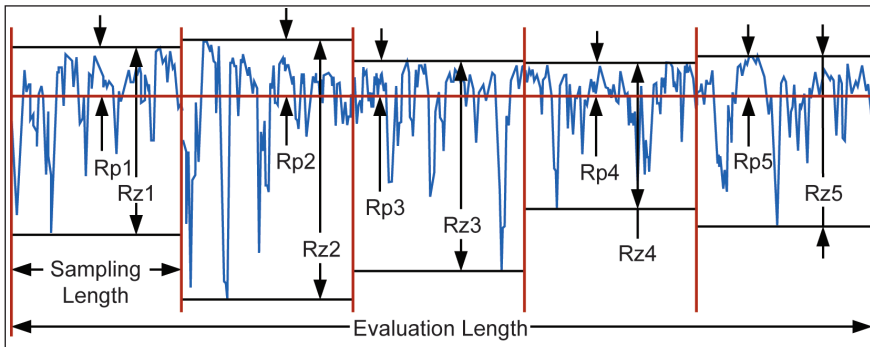

Figure 2-14.

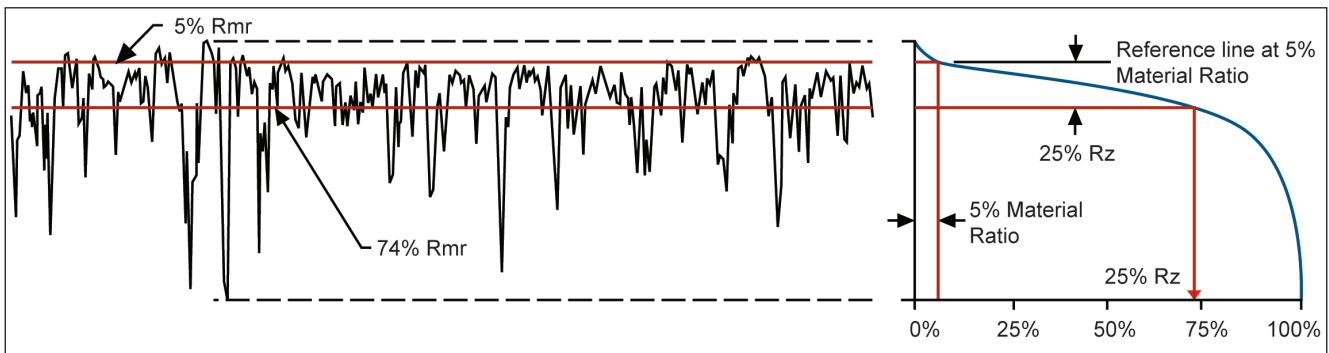

Figure 2-15.

Surface Finish Guidelines for Reciprocating Seals

Recommendations for surface roughness are different for static and dynamic surfaces. Static surfaces, such as seal groove diameters, are generally easier to seal and require less stringent roughness requirements; however, the type of fluid being sealed can affect the guidelines (see Table 2-8). It is important to remember that surface finish recommendations will vary depending upon the seal material of choice. PTFE seals require smoother finishes than seals made from polyurethane and most rubber compounds.

Four parameters have been selected to define a proper surface finish for hydraulic and pneumatic reciprocating applications. These parameters are Ra, Rp, Rz and Rmr. For descriptions of these parameters, please consult Table 2-8.

Grinding as a final process for dynamic sealing surfaces is rarely sufficient. In order to obtain an acceptable Rmr value, the surface must often be ground **and** polished. If the surface is not polished in addition to being ground, the ratio of Rp and Rz to Ra will be too high or Rmr ratio too low.

Table 2-8. Surface Finish Guidelines

Ra Guidelines				
Application	Thermoplastic and Rubber Seals		PTFE Seals	
	Dynamic Surfaces	Static Surfaces	Dynamic Surfaces	Static Surfaces
Cryogenics	—	—	4 µin (0.1 µm) maximum	8 µin (0.2 µm) maximum
Helium Gas Hydrogen Gas Freon	3 to 10 µin (0.08 to 0.25 µm)	12 µin (0.3 µm) maximum	6 µin (0.15 µm) maximum	12 µin (0.3 µm) maximum
Air Nitrogen Gas Argon Natural Gas Fuel (Aircraft and Automotive)	3 to 12 µin (0.08 to 0.3 µm)	16 µin (0.4 µm) maximum	8 µin (0.2 µm) maximum	16 µin (0.4 µm) maximum
Water Hydraulic Oil Crude Oil Sealants	3 to 12 µin (0.08 to 0.3 µm)	32 µin (0.8 µm) maximum	12 µin (0.3 µm) maximum	32 µin (0.8 µm) maximum
Rp Guidelines				
Application	Thermoplastic and Rubber Seals		PTFE Seals	
	Dynamic Surfaces	Static Surfaces	Dynamic Surfaces	Static Surfaces
All media/fluids	If Ra ≥ 5 µin (0.13 µm), then Rp ≤ 3 × Ra	—	If Ra ≥ 5 µin (0.13 µm), then Rp ≤ 3 × Ra	—
	If Ra < 5 µin (0.13 µm), then Rp ≤ 3.5 × Ra		If Ra < 5 µin (0.13 µm), then Rp ≤ 3.5 × Ra	
	Example: If Ra = 4 µin, then Rp ≤ 14 µin.			
Rz Guidelines				
Application	Thermoplastic and Rubber Seals		PTFE Seals	
	Dynamic Surfaces	Static Surfaces	Dynamic Surfaces	Static Surfaces
All media/fluids	Rz ≤ 8 × Ra and 70 µin (1.8 µm) maximum	Rz ≤ 6 × Ra	Rz ≤ 8 × Ra and 64 µin (1.6 µm) maximum	Rz ≤ 6 × Ra
	Example: If Ra = 4 µin, then Rz ≤ 32 µin (dynamic calculation)			
	Note: Rz values above maximum recommendations will increase seal wear rate.			
Rmr Guidelines				
Application	Thermoplastic and Rubber Seals		PTFE Seals	
	Dynamic Surfaces	Static Surfaces	Dynamic Surfaces	Static Surfaces
All media/fluids	45% to 70% (thermoplastic)	—	60% to 90%	—
	55% to 85% (rubber materials)			
	Rmr is measured at a depth of 25% of the Rz value based upon a reference level (zero line) at 5% material/bearing area.			



ENGINEERING

Surface Finish FAQs

What is the difference between RMS (Rq) and Ra?

RMS which stands for Root Mean Square (and now known as Rq), is one way of quantifying the average height of a surface. The Arithmetic Average, Ra, quantifies the surface in a different manner, providing a true mean value. These parameters will almost always be different, but there is not an exact relationship between the two for a typical sealing surface of random peaks and valleys. If a surface were to perfectly resemble a sine wave, the result would place the RMS value 11% higher than Ra, but this is not a very realistic scenario. On various ground and polished surfaces, RMS has been observed to be as much as 50% higher than Ra, but on average, runs about 30% higher. If this 30% average difference is applied to a 16 μm RMS specification, the maximum recommended value would be 12 μm Ra.

Why are Rp and Rz specified as a function of Ra, and not simply a range?

Take a shaft with the minimum recommended value of Ra = 3 μm , for example. Using the formula for Rz, the maximum value would be calculated as 24 μm (8 x 3). If the requirement simply stated a range that allowed Rz values up to 70 μm , this large difference indicates that the surface profile could have many large, thin surface peaks which would abrade the seal quickly. By the same regard, a maximum Ra value of 12 μm would result in an Rz value of 96 μm (12 x 8), which is beyond the recommended maximum value of 70 μm . The same principle applies for Rp: peaks should be removed to reduce seal wear via a polishing process. Grinding without polishing can leave many abrasive surface peaks.

Why is Ry (also known as Rmax) not used in Parker's roughness specification?

Ry only provides a single measurement (a vertical distance from one peak to valley) within the whole evaluation length. In actuality, there may be several peaks and valleys of similar height, or there may only be one large peak or valley. Rp and Rz provide much more accurate results, showing the average of five peak to valley measurements (one measurement in each of the five sampling lengths). Furthermore, ISO 4287:1997 and ISO 4288:1996 standards no longer incorporate the use of Ry.

How can a dynamic surface finish be too smooth?

There are two areas of concern that have been observed on extremely smooth surfaces, the first being seal wear, the second being leakage. When surface finishes have been measured at or below 1 μm Ra, an extremely accelerated seal wear rate has been observed. A small jump to 1.8 to 2 μm Ra shows significant improvement, indicating that the extremely low range should be avoided. With higher values showing even greater life extension, the optimal range for Ra has been determined to be 3 to 12 μm .

Regarding leakage, some seal designs that function well with 6 to 12 μm Ra finishes begin to leak when the finish falls below 3 μm Ra. Due to technological advances, there are many suppliers who manufacture rods with finishes this smooth. It is always necessary to validate seal performance, especially if using an ultra-smooth dynamic surface.

When does a dynamic surface finish become too rough?

Although it is possible for some seals to function when running on rough finishes, there are always concerns with accelerated wear and leakage control. Certain seals have been able to function at 120 μm Ra finishes for short periods of time, but seal life in these cases can be reduced up to five or six times. On the contrary, some seals have failed at surface finishes as low as 16 μm Ra when pressure was insufficient to effectively energize the sealing lips as they rapidly wore out. Even though a rough finish is not a guaranteed failure mode, it is always best to stay within the recommended specifications. Remember that a proper finish also meets the



recommendations for Rp, Rz and Rmr listed in the surface roughness guidelines.

Installation

Considerations

Installation techniques may vary considerably from case to case, depending on whether a seal is being replaced as a maintenance procedure or being installed in the original manufacture of reciprocating assemblies. Variations also arise from differences in gland design. A two-piece, split gland design, although rarely used, poses fewer problems than a “snap-in” groove positioned deep inside the body of a long rod gland. In production situations, or where frequent maintenance of similar or identical assemblies is performed, it is customary to utilize special tools to permit fitting a seal into its groove without overstressing it or subjecting it to nicks and cuts during insertion.

The common issues associated with all installation procedures are:

- 1. Cleanliness.** The seal and the hardware it must traverse on its way into the groove, as well as the tools used to install the seal, must be cleaned and wiped with lint-free cloths.
- 2. Nick and Cut Protection.** Threads, sharp corners and burrs can damage the seal. Care should be taken to avoid contact with these surfaces. Burrs must be removed, sharp corners should be blunted or radiused, and threads should be masked or shielded with special insertion tooling (see Figure 2-16). Although it is good practice to take extra care in the handling and manipulation of the seal, this

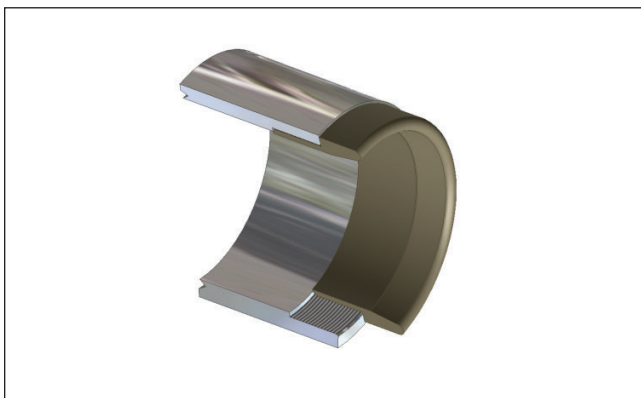

Figure 2-16. Thread protection installation tool cutaway view

is seldom sufficient and it usually requires either a safety tool or masking to protect the seal against such damage.

- 3. Lubrication.** Both the seal and its installation path must be lubricated prior to insertion. The lubricant should be selected for its compatibility

Table 2-9. Seal Installation Lubricants

Type	Temp. Range °F (°C)	Seal Use	Seal Material Compatibility
Petroleum base (Parker O Lube)	-20 to +180 (-29 to +82)	Hydrocarbon fluids; Pneumatic systems under 200 psi	Molythane®, Resilon®, Polymyte®, Nitroxile®, HNBR, NBR, FKM, (DO NOT use with EPR)
Silicone grease or oil (Parker Super O Lube)	-65 to +400 (-54 to +204)	General purpose; High pressure pneumatic	Molythane, Resilon, Polymyte, Nitroxile, HNBR, NBR, EPR, FKM
Barium grease	-20 to +300 (-29 to +149)	Pneumatic systems under 200 psi	Molythane, Resilon, Polymyte, Nitroxile, HNBR, NBR, FKM
Fluorocarbon fluid	-65 to +400 (-54 to +204)	Oxygen service	EPR

with the seal compound and the working fluid it will later encounter. Often, the working fluid itself can be used as the lubricant (see Table 2-9).

- 4. Lead-in Chamfer.** A generous lead-in chamfer will act as a guide to aid in seal installation. With

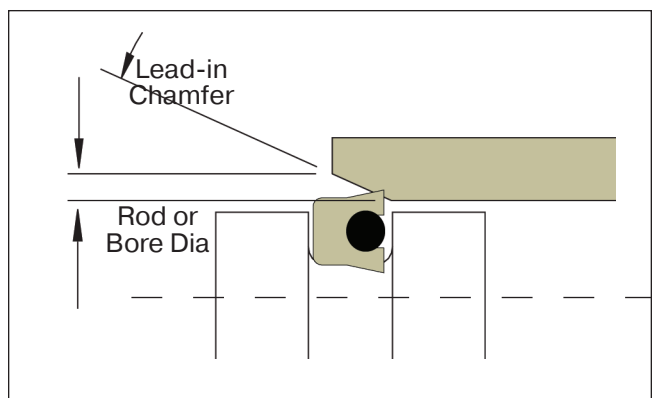

Figure 2-17. Seal installation lead-in chamfer

ENGINEERING

the proper lead-in chamfer, the seals can be installed without lip damage. Refer to Figure 2-17 below and [Table 2-6 on page 2-8](#) for proper lead-in chamfer dimensions.

5. Heating. Where harder or fabric-reinforced compounds are used in snap-in applications, elasticity of the seal may fall short of that required for stretching or compressing onto (or into) the groove. Since seal compounds characteristically exhibit a high thermal coefficient of expansion, and tend to soften somewhat when heated, it is sometimes possible to “soak” the seals in hot lubricant to aid installation. Be sure to observe the compound temperature limits, and avoid heating the seals while stretched. Heating a seal while stretched will invoke the Gow-Joule effect and actually shrink the seal.

6. Cross Section vs. Diameter. Care must be taken to properly match a seal’s cross-section to its diameter. If the cross-section is too large in relation to the diameter, it will be difficult to snap-in or stretch the seal into the groove.

8. Itemize and Use a Check List. All components required to complete a sealing assembly should be itemized and checked off as they are installed. The absence of any single component can cause the entire system to fail.

Table 2-10. Seal Cross Section vs. Diameter Installation Guide

Installation Guide Cross Section vs. Diameter				
Cross Section	Minimum Diameter Rod Seal		Minimum Diameter Piston Seal	
	Poly-urethane	Polymyte	Poly-urethane	Polymyte
1/8"	.750 I.D.	1.000 I.D.	1.250 I.D.	1.750 I.D.
3/16"	1.000 I.D.	1.750 I.D.	1.750 I.D.	2.750 I.D.
1/4"	1.750 I.D.	2.750 I.D.	3.000 I.D.	4.500 I.D.
3/8"	3.000 I.D.	5.000 I.D.	6.000 I.D.	8.000 I.D.
1/2"	6.000 I.D.	8.000 I.D.	10.000 I.D.	12.000 I.D.
3/4"	8.000 I.D.	9.000 I.D.	15.000 I.D.	17.000 I.D.
1"	10.000 I.D.	10.000 I.D.	20.000 I.D.	25.000 I.D.

This condition is typically only associated with polyurethane, Polymyte® and other high modulus materials. The data shown in Table 2-10 may be used as a guide to determine this relationship for ease of installation.

7. Installation Tools. Use installation tools as recommended ([see pages 2-16 and 2-17](#)).



Installation Tools — Piston Seals

The installation of piston seals can be greatly improved with the use of installation tooling. Tooling not only makes the installation easier, but also safer and cost effective for high volumes as seals are less likely to be damaged when using proper tooling. For piston seal installation using tooling, use the following steps:

1. Inspect all hardware and tooling for any contamination, burrs or sharp edges. Clean, debur, chamfer, or radius where necessary. Make sure the piston and groove are undamaged.
2. If using a two-piece energized cap seal, install the o-ring or rubber energizer into the groove per vendor specifications.
3. Install the expanding mandrel onto the piston (Figure 2-18).
4. Light lubrication and/or warming (+140°F max) may aide installation. Use system compatible lubricant only.
5. Place the seal onto the expanding mandrel, and using hand pressure or a pusher, if necessary, gently push the seal along the taper until it snaps into place (Figure 2-19).

6. If back-up rings are to be used, install split versions into their proper location or use the mandrel method in Step 5 for non-split rings.
7. For PTFE cap seals, slide the resizing tool over the seal to compress the seal to its original diameter (Figures 2-20, 2-21).

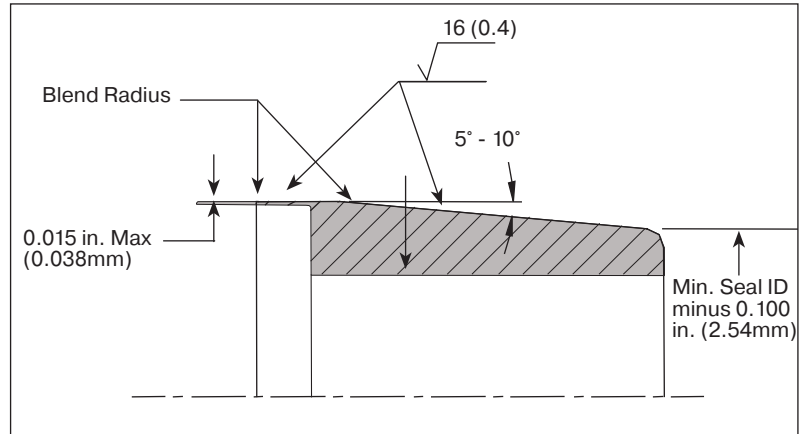

Figure 2-18. Expanding mandrel

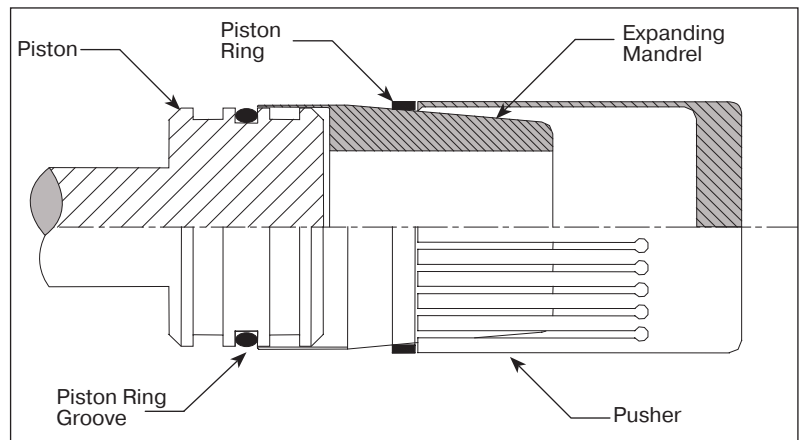

Figure 2-19. Installation of piston seal with tooling

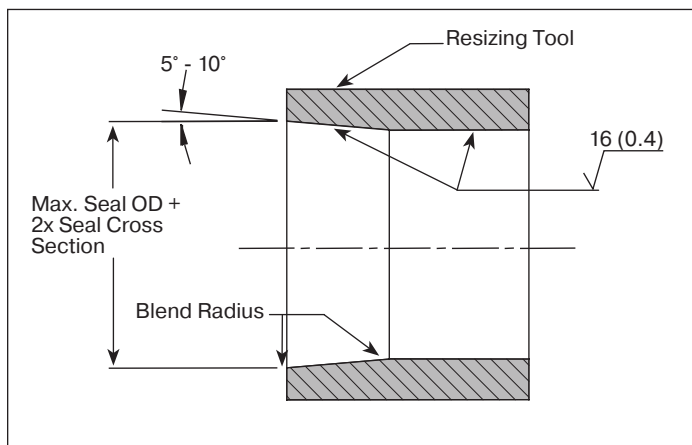

Figure 2-20. Resizing tool

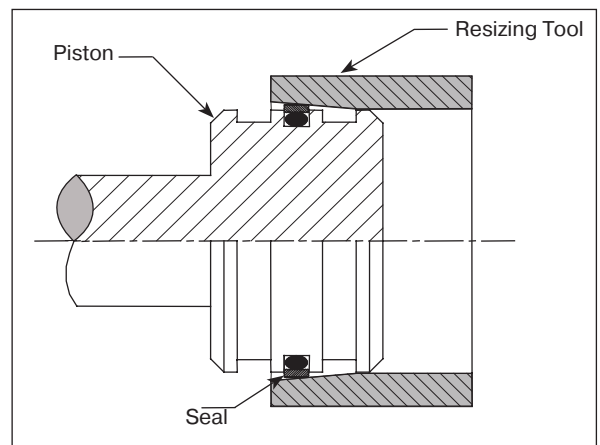

Figure 2-21. Resizing

Installation Tools — Rod Seals

Many rubber, plastic and PTFE rod seals can be manipulated by hand for installation into the seal groove. Small diameter parts or parts with large cross sections may require a two piece (split)

groove for installation. Special tooling can be utilized to help the installation process; however, PTFE and Polymyte® seals in particular require caution to ensure the sealing component is not nicked, dented or damaged. The following guidelines provide the steps for proper rod seal installation. If needed, please call your local Parker representative for recommendations.

1. Inspect all hardware and tooling for any contamination, burrs or sharp edges. Clean, debur, chamfer or radius where necessary. Make sure the bore, groove and rod are undamaged.
2. If using a two-piece, energized cap seal, first carefully install the o-ring or rubber energizer into the groove to ensure proper seating.
3. By hand, gently fold the seal into a kidney shape (Figure 2-22) and install into the groove. For rubber and polyurethane seals, the use of a three-prong installation tool can be helpful for folding the seal and installing it into the groove (Figure 2-23).
4. Unfold the seal into the groove, and using your finger, feel the inside diameter of the seal to make sure it is properly seated.
5. For PTFE seals, after unfolding the seal in the groove, use a resizing tool (Figure 2-24) to re-expand the seal.
6. If a back-up ring is to be used with the rod seal, position the seal toward the internal side of the groove to allow space for the back-up ring installation.

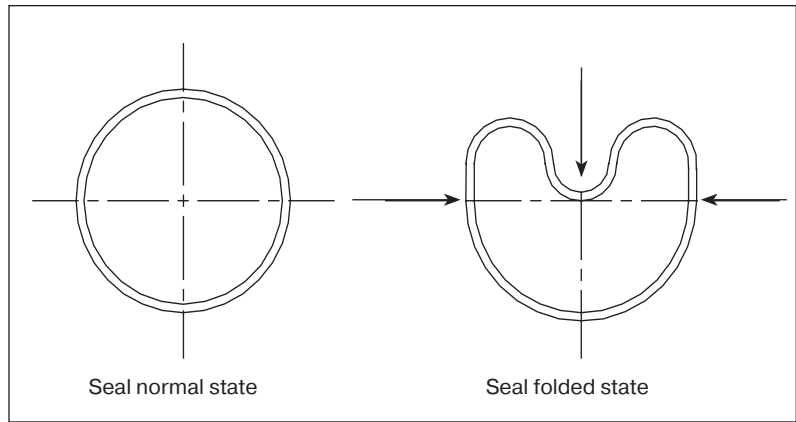

Figure 2-22. Rod seal folding

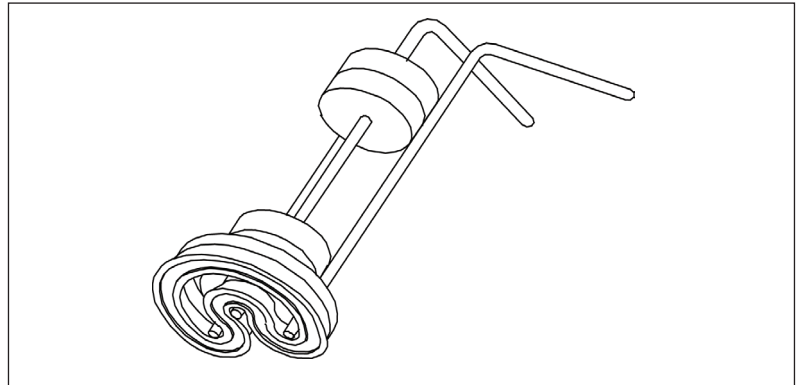

Figure 2-23. Three-leg installation tool for polyurethane and rubber seals

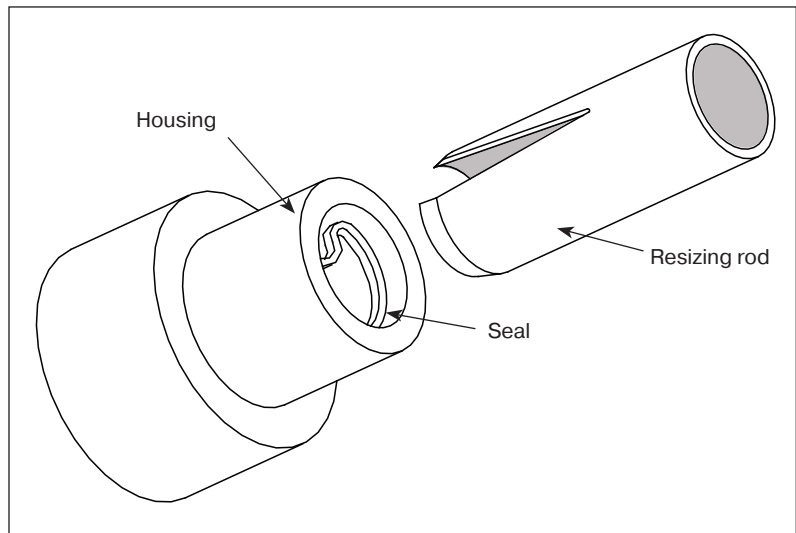

Figure 2-24. Rod seal installation

Finite Element Analysis

Finite Element Analysis (FEA) is a powerful computer simulation tool that allows engineers to evaluate product designs and materials and to consider “what if” scenarios in the development phase. FEA helps minimize time and cost by optimizing a design early in the process, reducing pre-production tooling and testing. Within the simulation program, the product being evaluated is divided into “finite elements,” and model parameters such as pressure and seal lip squeeze are defined. The program then repeatedly solves equilibrium equations for each element, creating an overall picture of seal deformation, stress and contact forces (see Figure 2-25). These results can then be linked to application testing to predict performance.

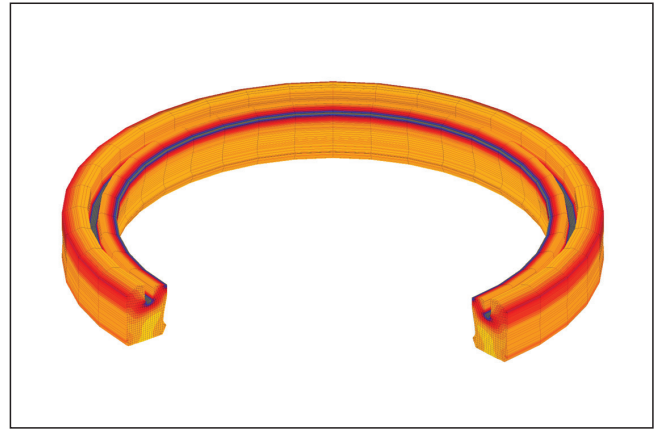

Figure 2-25.

Precise material characterization is an essential component of accurately modeling elastomeric products with FEA. Due to the complex nature of elastomers, multiple tests must be performed in order to determine their behavior under stress and strain. Figure 2-26 shows the typical nonlinear stress-strain curves for elastomers compared to the linear property of steel. These nonlinear complexities make performing FEA for elastomers much more difficult than for metal materials. Advances in material characterization are continually being made to improve the ability to capture and predict thermoviscoelastic effects of elastomers.

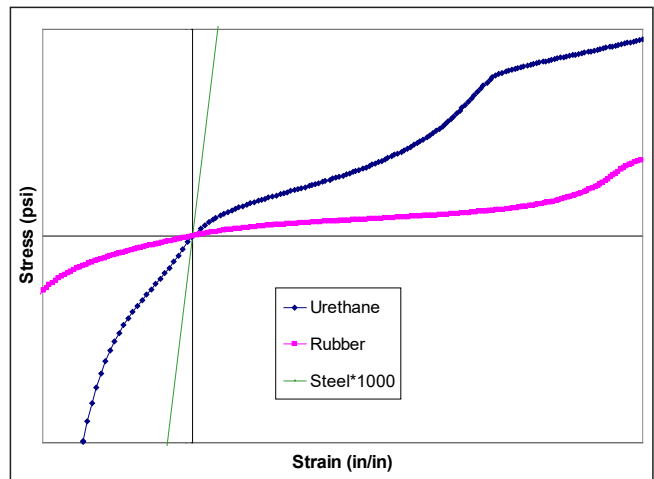

Figure 2-26. Stress/Strain relationship of steel vs. elastomers

FEA results must be linked with lab and field testing to create a baseline to predict seal performance. Once this baseline is established, design iterations can be performed within FEA until the desired results are achieved and an optimum design is predicted. This evaluation process enables engineers to anticipate the performance of new seal designs by minimizing the time and cost associated with prototype tooling investments (see Figure 2-27).

Like any computer simulation, FEA has its limitations. The cost of performing FEA should always be justified by its results. FEA can provide relative information on leakage performance and wear life, but cannot give concrete answers to questions like, “Will this seal leak, and if so, how much?” and “How many cycles can be expected before failure occurs?”

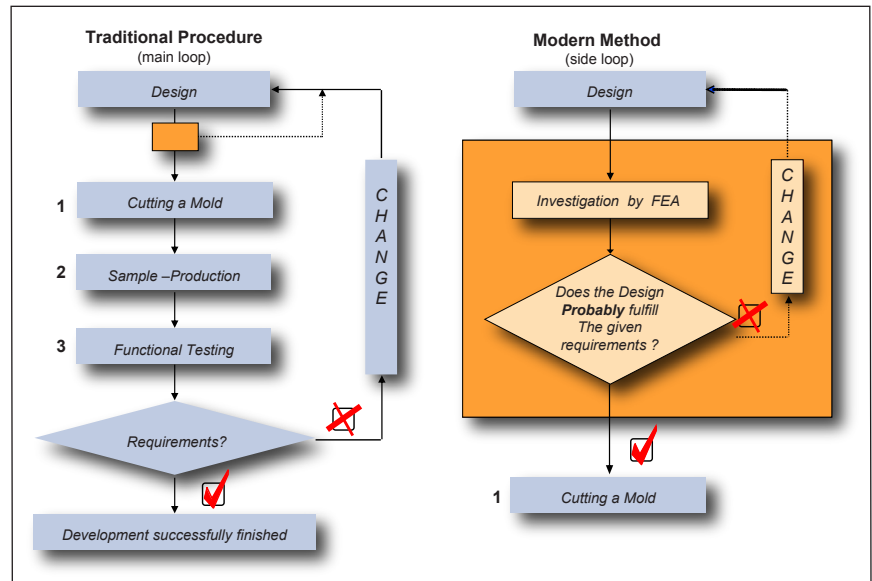

Figure 2-27. Traditional process vs. modern seal development process using FEA



Engineers arrive at two predominant selection outcomes when taking into consideration variables required to design a fluid sealing system — and both selections are integral to system performance:

- Seal geometry (profile configuration)
- Seal material

Parker's commitment to offering the highest quality sealing materials is unsurpassed in the industry. Our expansive portfolio of materials for dynamic sealing includes standard grade, high performance, custom, and specialty formulations.

MATERIALS FOR FLUID POWER PRODUCTS

Materials for fluid power products are selected to not only meet application requirements, but to optimize system performance.

Selection criteria includes:

- Typical physical properties which give a broad picture of a material's performance
- Chemical compatibility with system fluid
- Thermal capabilities and extrusion resistance to meet application requirements
- Friction and wear resistance for long service life



Resilon® 4300 Polyurethane D-Rings

Typical Physical Properties

Typical physical properties for products are shown in the corresponding tables.

Critical Note: Typical physical property data should be used as a tool for relative comparison of physical and mechanical properties of Parker materials within a material classification and are not given as specification limits.

Values shown are derived primarily from laboratory tests on material samples of uniform shape and size. Data does not take into account all variables that may be encountered in actual use such as seal geometry, lip shape, idle storage or exposure conditions, duration or other aspects of continuous operation, excursion temperatures, etc.

Therefore, it is imperative that the user/purchaser test any seal geometry/material combination being considered under actual service conditions before specifying. If this is not practical, tests should be devised that simulate service conditions as closely as possible.

THERMOPLASTICS — ELASTOMERS

Parker Material Code	Material Trade Name (Color)	Typical Applications and Description	Service Temperature Range °F (°C)	Tensile Strength at Break psi (MPa)	Ultimate Elongation	Hardness	100% Modulus psi (MPa)	Compression Set		Rebound	Abrasion Rating Best = 10
								Set	at °F (°C)		
Thermoplastic Elastomers — TPU, Polyurethanes											
P4300A90	Polyurethane Resilon® 4300 (Tan)	Proprietary compound offering extended temperature range, high rebound. USP Class VI certified.	-65 to +275 (-54 to +135)	8500 (58.6)	580%	92A	1750 (12.1)	17%	+158 (+70)	63%	10
								29%	+212 (+100)		
P4301A90 (oil)	Polyurethane Resilon® 4301 (Aqua)	For petroleum based fluids.	-35 to +275 (-37 to +135)	6800 (46.9)	490%	91A	1850 (12.8)	22%	+158 (+70)	39%	9
		For water based fluids. USP Class VI certified.	-35 to +225 (-37 to +107)								
P4304D60	Polyurethane Resilon® 4304 (Brown)	Offers higher extrusion resistance for seals and anti-extrusion devices.	-65 to +275 (-54 to +135)	7800 (53.8)	530%	60D	3000 (20.7)	36%	+158 (+70)	49%	9
P4700A90	Polyurethane (Green)	Enhanced properties over 4615 to improve sealing capabilities from lower compression set.	-65 to +200 (-54 to +93)	5900 (40.7)	520%	94A	1600 (11.0)	22%	+158 (+70)	40%	8
P5065A88	Polyurethane (Dark Blue)	Formulated for an improved low temperature range and higher resilience than 4615, NSF/ANSI 61 certified.	-70 to +200 (-57 to +93)	7200 (49.6)	590%	87A	1000 (6.9)	24%	+158 (+70)	58%	7

THERMOPLASTICS — ENGINEERED RESINS

Parker Material Code	Material (Color)	Typical Applications and Description	Service Temperature Range °F (°C)	Tensile Strength psi (MPa)	Tensile Elongation (%)	Notched IZOD Impact Strength ft-lbs/in.	Flexural Strength psi (MPa)	Flexural Modulus Kpsi (MPa)	Compressive Strength psi (MPa)	Water Absorption (24 Hr) %
Nylons										
W4778	Glass-Filled Nylon (Black)	High compressive strength, internally lubricated, 40% glass-filled nylon for tight tolerance wear rings	-65 to +275 (-54 to +135)	29750 (205)	2.5	2.9	41550 (286)	1900 (13100)	28500 (196)	0.20



MATERIALS

Typical Physical Properties

PTFE

Parker Material Code	Material Color	Typical Applications and Description	Service Temperature Range °F (°C)	Tensile Strength in psi at Break (bar)	Elongation %	Hardness	Coefficient of Friction	Thermal Conductivity (in W/mK)	Coefficient of Thermal Expansion (in/in/°F x 10 ⁻⁵ at 203°F)	Permanent Deformation Under Load (70°F 2000 psi in %)	Abrasion Rating Best = 10
Filled PTFE											
0102	Pigmented PTFE (Turquoise)	Lower creep, reduced permeability and good wear resistance.	-320 to +450 (-195 to +233)	4600 (317)	390	60 D	0.05 - 0.10	0.29	6.1	6.9	3
0307	Carbon Graphite Filled PTFE (Black)	Excellent wear resistance and reduced creep.	-250 to +575 (-157 to +302)	2250 (155)	100	64 D	0.8 - 0.11	0.35	4.4	2.5	5
0401	Bronze Filled PTFE (Bronze)	Excellent extrusion resistance and high compressive loads. 62 Shore D.	-200 to +575 (-129 to +302)	3200 (221)	250	62 D	0.18 - 0.22	0.45	5.6	4.4	5
0502	Carbon Fiber Filled PTFE (Brown)	Good for strong alkali and hydrofluoric acid. Good in water service. 60 Shore D.	-200 to +550 (-129 to +288)	3200 (221)	150	60 D	0.09 - 0.12	0.31	7.2	1.8	8
0627	PPS + Graphite-filled PTFE (Dark Gray)	Good wear resistance, non-abrasive against shafts, lower creep.	-250 to +550 (-157 to +288)	2500 (172)	260	64 D	0.12 - 0.16	0.28	5.2	3.2	6

Note: We emphasize that these tabulations should be used as a guide only.

The above data is based primarily on laboratory and service tests, but does not take into account all variables that can be encountered in actual use. Therefore, it is always advisable to test the material under actual service conditions before specifying. If this is not practical, tests should be devised that simulate service conditions as closely as possible.



Chemical Compatibility

It is essential to select seal compounds that are compatible with the environment in which they are used. Even if the proper seal material is chosen based on system temperature and pressure, exposure to certain fluids can drastically reduce seal performance by altering a compound's typical physical properties.

Parker has tested thousands of fluids and is continuously testing many new, popular chemicals to ensure seal material compatibility. For detailed reports regarding compatibility of common seal materials and popular test fluids, please contact your local Parker Engineered Materials Group representative.

Temperature Limits

It is important to understand that temperature ratings for sealing materials are based upon the typical physical characteristics of the material alone. A material's suitability for a specific application, however, is dependent on actual use conditions which take into account wide ranging considerations which include, but are not limited to: hardware attributes and configuration, seal geometry, fluid compatibility, and expected duration and frequency of service exposure at pressure, temperature, and speed (i.e., continuous, intermittent, excursion). Therefore, it is always advisable to test under actual service conditions before specifying a material.

THERMAL FACTORS

Heat affects the seal material in several ways:

- Softens the material which accelerates wear
- Accelerates any chemical reaction between the fluid and the seal
- Damages the bond structure of the material
- Increases compression set
- Higher temperatures for extended periods of time may harden thermoset (rubber) materials.
- As a bearing or wear ring heats up, binding can occur if there is not a gap designed into the wear ring.

Lower end temperature may be as important as the upper end temperature. This is especially true in mobile hydraulics. As the temperature lowers, the following takes place:

- The seal hardens and is less responsive.
- The coefficient of thermal expansion and contraction is approximately ten times that of metals. Therefore the seal lips could start to pull away from the surface of the bore. This loss of lip compression against the colder sealing surfaces can be offset by seal design and proper material selection.



Storage and Handling

In 1998, the Society of Automotive Engineers (SAE) issued an Aerospace Recommended Practice (ARP) for the storage of elastomer seals and seal assemblies prior to installation (ARP 5316). The shelf lives listed in ARP 5316 are limited to materials supplied to various AMS and US Military specifications. At Parker, we have expanded on that list. This has meant grouping compounds by polymer family and assigning that family a uniform shelf life. The shelf life of each polymer family as practiced by Parker EPS Division is shown in the Recommended Storage Standards table shown here.

The values in the chart assume that proper guidelines for storage conditions are followed. If plastic and rubber products are stored improperly, their physical properties may change. Prior to use, all parts should be checked for hardness, surface cracking or peeling. If any of these conditions are observed, the parts should be discarded. Some compounds can exhibit a build-up of powdery film on their surface over time. This natural occurrence is referred to as bloom and does not in any way negatively impact the function of the seal. Guidelines for proper seal storage are shown below.

RECOMMENDED STORAGE STANDARDS

Polymer Family	Storage Life
SBR	3 Years
Polyurethane, PU, TPE, TPCE (Polymyte®)	10 Years
Nitrile, Neoprene, HNBR, Polyacrylate, Natural Rubber, CSM	15 Years
Ethylene Propylene, Fluorocarbon, Perfluorinated Elastomer, Butyl, Silicone, Fluoro-silicone, Polytetrafluoroethylene (PTFE), Tetrafluoroethylene Propylene (Aflas®)	Unlimited





SEAL STORAGE and HANDLING GUIDELINES

Records	Records should be kept to ensure that stock is rotated such that the first seals in are the first out (FIFO).
Temperature	Seals must be stored away from heat sources such as direct sunlight and heating appliances. Maximum storage temperature is +100°F (+38°C). Low temperatures do not typically cause permanent damage to seals, but can result in brittleness, making them susceptible to damage if not handled carefully. Ideally, seals should not be stored at temperatures less than +50°F (+10°C) and should be warmed to room temperature before installation.
Ultra Violet	Seals must be protected from direct sunlight and any artificial light that generates ultra violet radiation.
Humidity	Care should be taken to ensure seals are always stored in an environment with a relative humidity of less than 65%. Polyurethane seals in particular are very susceptible to damage from exposure to moisture and should be stored in air-tight containers.
Oxygen and Ozone	Ozone-generating equipment and oxygen exposure can be detrimental to seal compounds. Seals should be stored in air-tight containers. Any electrical equipment that generates a spark should not be used near seal storage.
Contamination	Keeping seals free from contamination will assist promote service life. Good housekeeping practices should be maintained.
Distortion	Large seals should be stored flat when possible and not suspended, which may cause distortion over time. Do not store seals on hooks, nails or pegboard.



Parker rod seal profiles represent the latest in advanced sealing technology for today's fluid power equipment. The combination of optimized geometry and high performance material results in highly engineered designs that offer the best possible solution for long life and improved performance.

ROD SEAL PROFILES

Profile	Cross Section	Description	Pressure Max* psi	Standard Material		Page
				4300	5065	
Rod Seal Decision Tree						14
BT		Primary rod seal. U-cup seal with secondary stabilizing lip	5000	•		15
BD		Primary rod seal. O-ring energized lip seal	5000	•		20
BD with Back-up Ring		Primary rod seal. O-ring energized lip seal with nylon back-up ring	10000		•	24
BR		Compact buffer seal with nylon back-up ring	10000	•		28

*Max pressure without wear rings. See profile detail page for max pressure when using wear rings. Consult Fluid Power Seal Design Guide, Catalog EPS 5370.



Rod Seal Decision Tree

Hydraulic

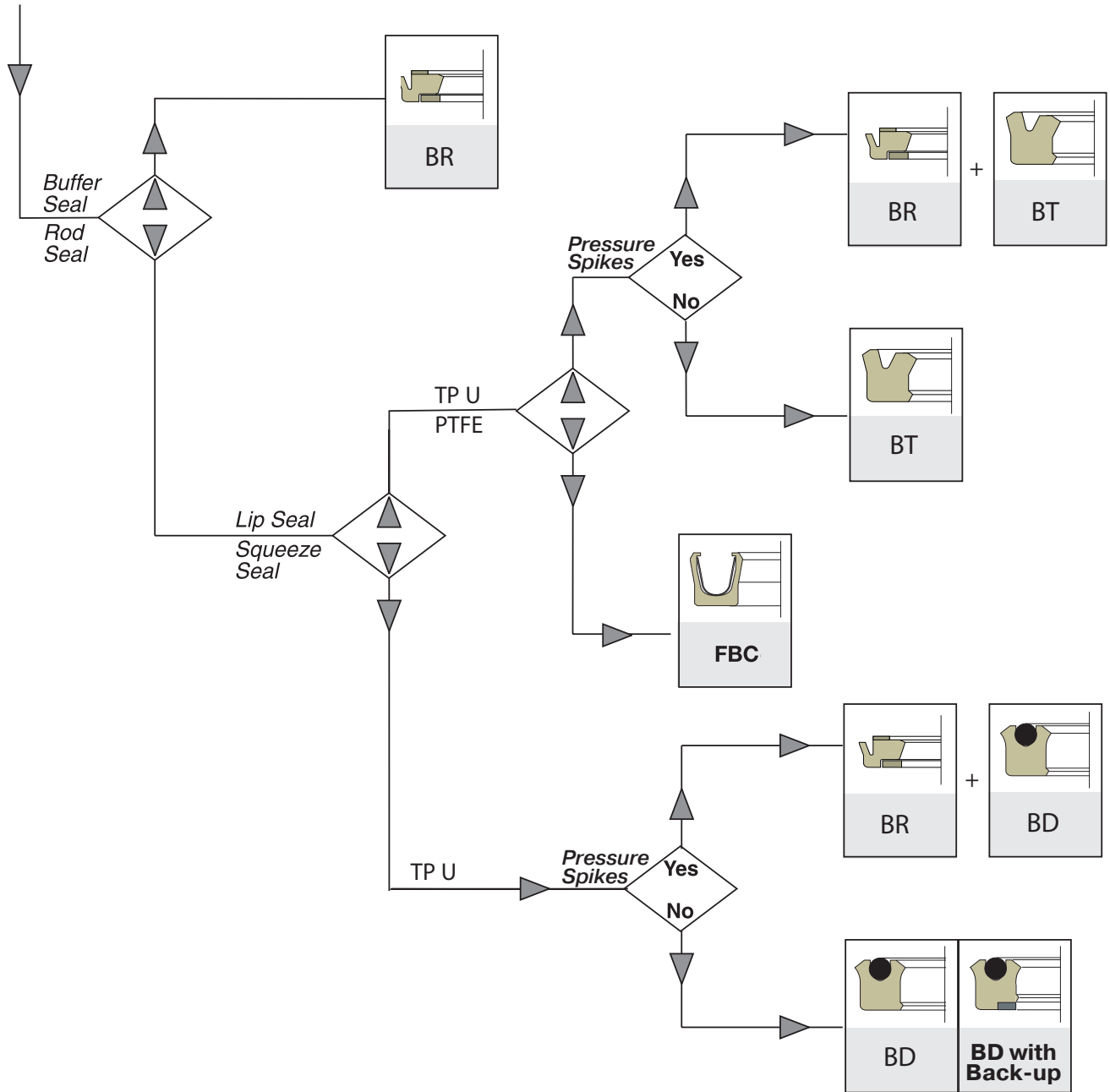

BT Profile

The BT profile is a non-symmetrical design for use in hydraulic rod sealing applications. Using Finite Element Analysis, the BT profile was designed to provide improved sealing performance and stability in the gland. A knife trimming process is used to form the beveled lip which is best for removing fluid from the rod. The standard material for the BT profile is Parker's proprietary 4300 Resilon® polyurethane.

The BT profile is designed for use as a stand alone rod seal or for use with the BR buffer seal for more critical sealing applications.

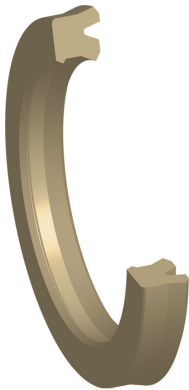

RANGE OF APPLICATION

Standard Material
P4300A90

Temperature	Pressure*	Speed
-65°F to +275°F (-54°C to +135°C)	5000 psi (344 bar)	< 1.6 ft/s (0.5 m/s)

**Pressure Range without wear rings. If used with wear rings, refer to the Engineering Section in Catalog EPS 5370.*

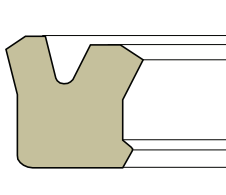

BT Cross-Section

- Premium U-cup rod seal
- Beveled sealing lip
- Secondary stabilizing lip in heel
- Long life, wear-resistant, extrusion resistant polyurethane
- Low compression set
- Shock load resistance
- Increased sealing performance at zero pressure

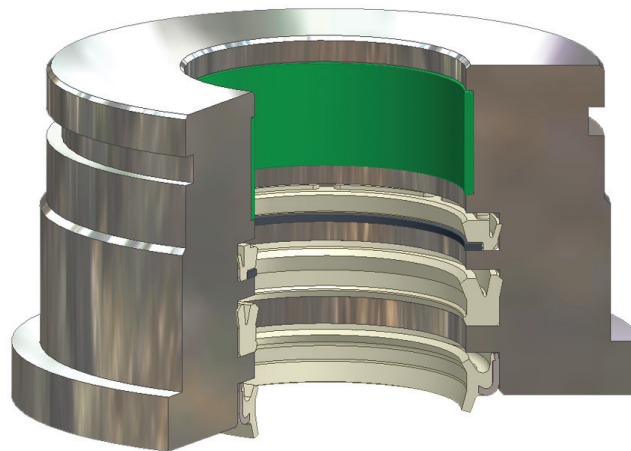

BT Installed in Rod Gland

BT Profile

PART NUMBER NOMENCLATURE

BT Profile – Inch

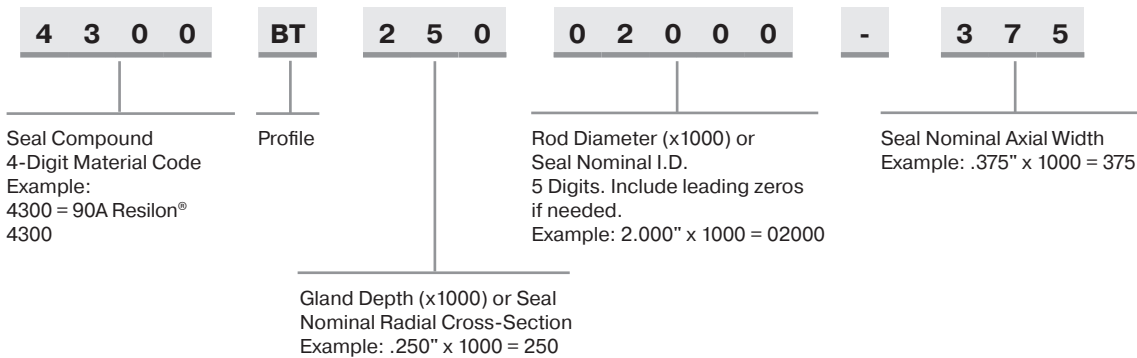

GLAND DIMENSIONS – BT Profile

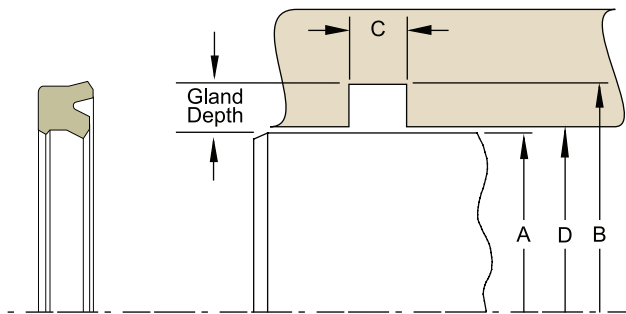

Please refer to the [Engineering Section](#) for surface finish and additional hardware considerations.

ROD GLAND DIMENSIONS – BT Profile – Inch

Hardware Dimensions							Part Number
A Rod Diameter		B Groove Diameter		C Groove Width	D Throat Diameter*		
Dia.	Tol.	Dia.	Tol.	+.015/- .000	Dia.	Tol.	
0.250	+.000/- .001	0.500	+.002/- .000	0.206	0.251	+.002/- .000	4300BT12500250-187
0.312	+.000/- .001	0.562	+.002/- .000	0.206	0.313	+.002/- .000	4300BT12500312-187
0.375	+.000/- .001	0.625	+.002/- .000	0.206	0.376	+.002/- .000	4300BT12500375-187
0.437	+.000/- .001	0.687	+.002/- .000	0.206	0.438	+.002/- .000	4300BT12500437-187
0.500	+.000/- .001	0.750	+.002/- .000	0.206	0.501	+.002/- .000	4300BT12500500-187
0.625	+.000/- .001	0.875	+.002/- .000	0.275	0.626	+.002/- .000	4300BT12500625-250

*If used with wear rings, refer to wear ring throat diameter.

Above table reflects recommended cross-sections for rod diameters shown. Alternate cross-sections and additional sizes may be considered. Consult your Parker representative for assistance.



BT Profile

ROD GLAND DIMENSIONS — BT Profile — Inch (cont'd)

Hardware Dimensions							Part Number
A Rod Diameter		B Groove Diameter		C Groove Width	D Throat Diameter*		
Dia.	Tol.	Dia.	Tol.	+ .015/- .000	Dia.	Tol.	
0.750	+ .000/- .001	1.000	+ .002/- .000	0.275	0.751	+ .002/- .000	4300BT12500750-250
0.875	+ .000/- .001	1.125	+ .002/- .000	0.275	0.876	+ .002/- .000	4300BT12500875-250
1.000	+ .000/- .002	1.375	+ .002/- .000	0.343	1.001	+ .002/- .000	4300BT18701000-312
1.125	+ .000/- .002	1.500	+ .002/- .000	0.343	1.126	+ .002/- .000	4300BT18701125-312
1.250	+ .000/- .002	1.625	+ .002/- .000	0.343	1.251	+ .002/- .000	4300BT18701250-312
1.375	+ .000/- .002	1.750	+ .002/- .000	0.343	1.376	+ .002/- .000	4300BT18701375-312
1.500	+ .000/- .002	1.875	+ .002/- .000	0.413	1.501	+ .002/- .000	4300BT18701500-375
1.625	+ .000/- .002	2.000	+ .002/- .000	0.413	1.626	+ .002/- .000	4300BT18701625-375
1.750	+ .000/- .002	2.125	+ .002/- .000	0.413	1.751	+ .002/- .000	4300BT18701750-375
1.875	+ .000/- .002	2.250	+ .002/- .000	0.413	1.876	+ .002/- .000	4300BT18701875-375
2.000	+ .000/- .002	2.500	+ .003/- .000	0.413	2.001	+ .003/- .000	4300BT25002000-375
2.125	+ .000/- .002	2.625	+ .003/- .000	0.413	2.126	+ .003/- .000	4300BT25002125-375
2.250	+ .000/- .002	2.750	+ .003/- .000	0.413	2.251	+ .003/- .000	4300BT25002250-375
2.375	+ .000/- .002	2.875	+ .003/- .000	0.413	2.376	+ .003/- .000	4300BT25002375-375
2.500	+ .000/- .002	3.000	+ .003/- .000	0.413	2.501	+ .003/- .000	4300BT25002500-375
2.625	+ .000/- .002	3.125	+ .003/- .000	0.413	2.626	+ .003/- .000	4300BT25002625-375
2.750	+ .000/- .002	3.250	+ .003/- .000	0.413	2.751	+ .003/- .000	4300BT25002750-375
3.000	+ .000/- .002	3.500	+ .003/- .000	0.413	3.001	+ .003/- .000	4300BT25003000-375
3.250	+ .000/- .002	3.750	+ .003/- .000	0.413	3.251	+ .003/- .000	4300BT25003250-375
3.500	+ .000/- .002	4.125	+ .004/- .000	0.550	3.502	+ .003/- .000	4300BT31203500-500
3.750	+ .000/- .002	4.375	+ .004/- .000	0.550	3.752	+ .003/- .000	4300BT31203750-500
4.000	+ .000/- .002	4.625	+ .004/- .000	0.550	4.002	+ .003/- .000	4300BT31204000-500
4.250	+ .000/- .002	4.875	+ .004/- .000	0.550	4.252	+ .003/- .000	4300BT31204250-500
4.500	+ .000/- .002	5.125	+ .004/- .000	0.550	4.502	+ .003/- .000	4300BT31204500-500
4.750	+ .000/- .002	5.375	+ .004/- .000	0.550	4.752	+ .003/- .000	4300BT31204750-500
5.000	+ .000/- .002	5.750	+ .005/- .000	0.688	5.002	+ .004/- .000	4300BT37505000-625
5.500	+ .000/- .002	6.250	+ .005/- .000	0.688	5.502	+ .004/- .000	4300BT37505500-625
6.000	+ .000/- .002	6.750	+ .005/- .000	0.688	6.002	+ .004/- .000	4300BT37506000-625
6.500	+ .000/- .002	7.250	+ .005/- .000	0.688	6.502	+ .004/- .000	4300BT37506500-625
7.000	+ .000/- .002	7.750	+ .005/- .000	0.688	7.002	+ .004/- .000	4300BT37507000-625
7.500	+ .000/- .003	8.500	+ .007/- .000	0.825	7.502	+ .005/- .000	4300BT50007500-750
8.000	+ .000/- .003	9.000	+ .007/- .000	0.825	8.002	+ .005/- .000	4300BT50008000-750
8.500	+ .000/- .003	9.500	+ .007/- .000	0.825	8.502	+ .005/- .000	4300BT50008500-750
9.000	+ .000/- .003	10.000	+ .007/- .000	0.825	9.002	+ .005/- .000	4300BT50009000-750
9.500	+ .000/- .003	10.500	+ .007/- .000	0.825	9.502	+ .005/- .000	4300BT50009500-750
10.000	+ .000/- .003	11.000	+ .007/- .000	0.825	10.002	+ .005/- .000	4300BT50010000-750

*If used with wear rings, refer to wear ring throat diameter.

Above table reflects recommended cross-sections for rod diameters shown. Alternate cross-sections and additional sizes may be considered. Consult your Parker representative for assistance.



BT Metric Profile

PART NUMBER NOMENCLATURE

BT Profile – Metric

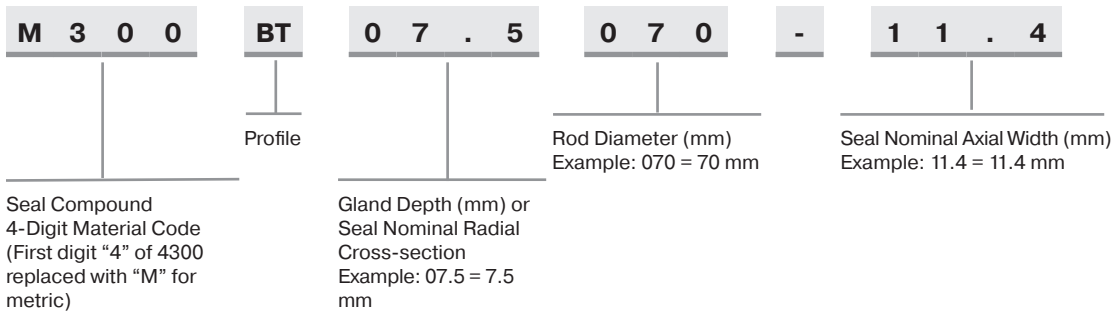

GLAND DIMENSIONS — BT Metric Profile

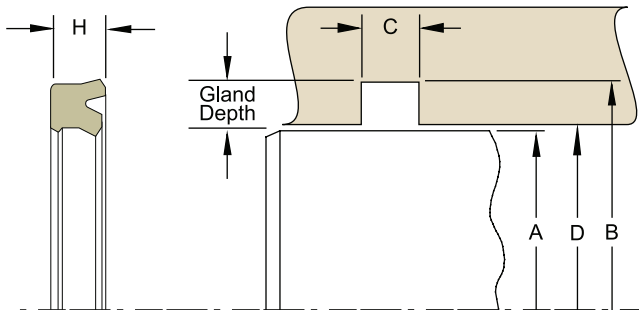

Please refer to the [Engineering Section](#) for surface finish and additional hardware considerations.

*In the case of designs according to ISO standard, the radii given there should be used.

BT Metric Profile

GLAND DIMENSIONS and PART NUMBER — BT Metric Profile

A Rod Diameter		B Groove Diameter		C Groove Width	D Throat Diameter*		H Part Height	ISO ¹	ISO ²	Part Number
Dia.	Tol. (F7)	Dia.	Tol. (H9)	+ .25/- .00	Dia.	Tol. (H8)				
25	-.02/-.04	35	+.06/-.00	8.0	25.0	+.03/-.00	7.3		•	M300BT05.0025-7.3
28	-.02/-.04	36	+.06/-.00	6.3	28.0	+.03/-.00	5.7	•	•	M300BT04.0028-5.7
32	-.03/-.05	42	+.06/-.00	8.0	32.0	+.03/-.00	7.3		•	M300BT05.0032-7.3
36	-.03/-.05	44	+.06/-.00	6.3	36.0	+.04/-.00	5.7	•	•	M300BT04.0036-5.7
40	-.03/-.05	50	+.06/-.00	8.0	40.0	+.04/-.00	7.3		•	M300BT05.0040-7.3
45	-.03/-.05	53	+.07/-.00	6.3	45.0	+.04/-.00	5.6	•	•	M300BT04.0045-5.6
50	-.03/-.05	60	+.07/-.00	8.0	50.0	+.04/-.00	7.3		•	M300BT05.0050-7.3
55	-.03/-.06	65	+.07/-.00	8.0	55.0	+.05/-.00	7.3			M300BT05.0055-7.3
56	-.03/-.06	66	+.07/-.00	7.5	56.0	+.05/-.00	6.5	•	•	M300BT05.0056-6.5
63	-.03/-.06	78	+.07/-.00	12.5	63.0	+.05/-.00	11.4		•	M300BT07.5063-11.4
65	-.03/-.06	80	+.07/-.00	10.0	65.0	+.05/-.00	9.0			M300BT07.5065-9
70	-.03/-.06	85	+.07/-.00	12.5	70.0	+.05/-.00	11.4		•	M300BT07.5070-11.4
80	-.03/-.06	95	+.09/-.00	10.0	80.0	+.05/-.00	9.0			M300BT07.5080-9
80	-.03/-.06	95	+.09/-.00	12.5	80.0	+.05/-.00	11.4		•	M300BT07.5080-11.4
100	-.04/-.07	120	+.09/-.00	16.0	100.0	+.06/-.00	14.5		•	M300BT10.0100-14.5
110	-.04/-.07	125	+.10/-.00	10.6	110.0	+.06/-.00	9.6	•	•	M300BT07.5110-9.6
125	-.04/-.08	145	+.10/-.00	16.0	125.0	+.06/-.00	14.5		•	M300BT10.0125-14.5
140	-.04/-.08	155	+.10/-.00	10.6	140.0	+.06/-.00	9.6	•	•	M300BT07.5140-9.6
160	-.04/-.08	185	+.12/-.00	20.0	160.0	+.06/-.00	18.2		•	M300BT07.5160-18.2
180	-.04/-.08	205	+.12/-.00	20.0	180.0	+.06/-.00	18.2		•	M300BT12.5180-18.2
200	-.05/-.10	225	+.12/-.00	20.0	200.0	+.07/-.00	18.2		•	M300BT12.5200-18.2
220	-.05/-.10	259	+.12/-.00	25.0	220.0	+.07/-.00	22.7		•	M300BT15.0220-22.7
250	-.05/-.10	280	+.13/-.00	25.0	250.0	+.07/-.00	22.7		•	M300BT15.0250-22.7
280	-.06/-.11	310	+.13/-.00	25.0	280.0	+.08/-.00	22.7		•	M300BT15.0280-22.7

*If used with wear rings, refer to wear ring throat diameter.

1) For housings according to ISO 5597 for ISO6020/II-cylinders.

2) Standard sizes for housings according to ISO 5597/I.



BD Profile

The BD profile is a non-symmetrical profile rod seal. The O-ring energizer functions as a spring to maintain sealing contact under low pressure or vacuum applications. The knife trimmed, beveled lip does an excellent job wiping fluid film. A stabilizing lip is located below the primary sealing lip, just above the base of the seal, to provide enhanced sealing performance and ensure a tight, stable fit in the gland. The standard material for the BD profile is Parker's proprietary 4300 Resilon® polyurethane.

The BD profile is designed to be used as a stand alone rod seal or for use with the BR profile buffer seal for more critical sealing applications.

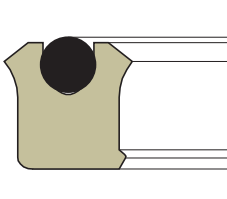
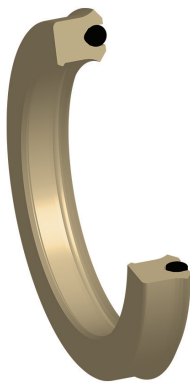

BD Cross-Section

RANGE OF APPLICATION

Standard Material

Elastomer
P4300A90

Energizer
N, 70A Nitrile

Temperature
-65°F to +275°F
(-54°C to +135°C)

Pressure*
5000 psi
(344 bar)

Speed
< 1.6 ft/s
(0.5 m/s)

**Pressure Range without wear rings. If used with wear rings, refer to the Engineering Section in Catalog EPS 5370.*

- Premium O-ring energized lip seal
- Excellent sealing under low/zero pressure conditions
- Beveled sealing lip
- Rectangular cross section and secondary lip in heel ensure stability in the gland
- Long life, wear-resistant, extrusion resistant polyurethane
- Low compression set
- Shock load resistant

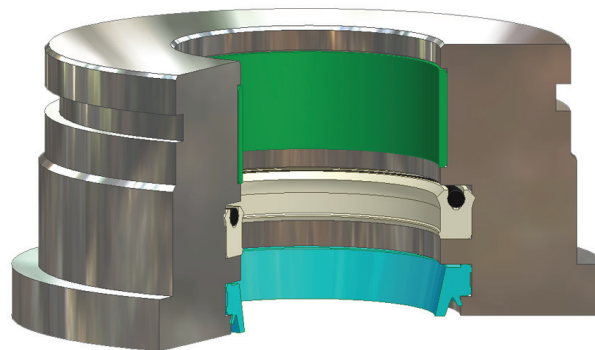

BD Installed in Rod Gland

BD Profile

PART NUMBER NOMENCLATURE BD Profile – Inch

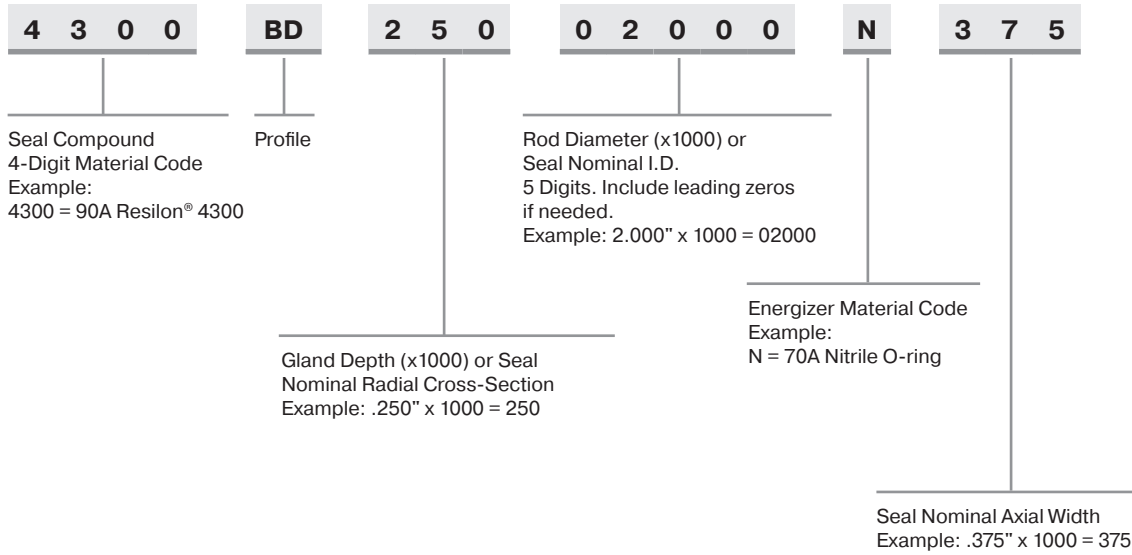

GLAND DIMENSIONS – BD Profile

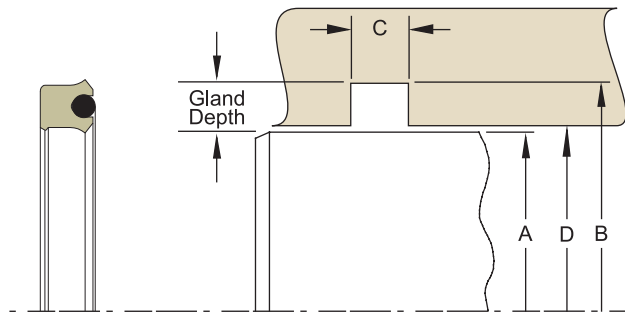

Please refer to the [Engineering Section](#) for surface finish and additional hardware considerations.

BD Profile

ROD GLAND DIMENSIONS — BD Profile — Inch

Hardware Dimensions							Part Number
A Rod Diameter		B Groove Diameter		C Groove Width	D Throat Diameter*		
Dia.	Tol.	Dia.	Tol.	+ .015/- .000	Dia.	Tol.	
0.250	+ .000/- .001	0.500	+ .002/- .000	0.206	0.251	+ .002/- .000	4300BD12500250N187
0.312	+ .000/- .001	0.562	+ .002/- .000	0.206	0.313	+ .002/- .000	4300BD12500312N187
0.375	+ .000/- .001	0.625	+ .002/- .000	0.206	0.376	+ .002/- .000	4300BD12500375N187
0.437	+ .000/- .001	0.687	+ .002/- .000	0.206	0.438	+ .002/- .000	4300BD12500437N187
0.500	+ .000/- .001	0.750	+ .002/- .000	0.206	0.501	+ .002/- .000	4300BD12500500N187
0.625	+ .000/- .001	0.875	+ .002/- .000	0.275	0.626	+ .002/- .000	4300BD12500625N250
0.750	+ .000/- .001	1.000	+ .002/- .000	0.275	0.751	+ .002/- .000	4300BD12500750N250
0.875	+ .000/- .001	1.125	+ .002/- .000	0.275	0.876	+ .002/- .000	4300BD12500875N250
1.000	+ .000/- .002	1.375	+ .002/- .000	0.343	1.001	+ .002/- .000	4300BD18701000N312
1.125	+ .000/- .002	1.500	+ .002/- .000	0.343	1.126	+ .002/- .000	4300BD18701125N312
1.250	+ .000/- .002	1.625	+ .002/- .000	0.343	1.251	+ .002/- .000	4300BD18701250N312
1.375	+ .000/- .002	1.750	+ .002/- .000	0.343	1.376	+ .002/- .000	4300BD18701375N312
1.500	+ .000/- .002	1.875	+ .002/- .000	0.413	1.501	+ .002/- .000	4300BD18701500N375
1.625	+ .000/- .002	2.000	+ .002/- .000	0.413	1.626	+ .002/- .000	4300BD18701625N375
1.750	+ .000/- .002	2.125	+ .002/- .000	0.413	1.751	+ .002/- .000	4300BD18701750N375
1.875	+ .000/- .002	2.250	+ .002/- .000	0.413	1.876	+ .002/- .000	4300BD18701875N375
2.000	+ .000/- .002	2.500	+ .003/- .000	0.413	2.001	+ .003/- .000	4300BD25002000N375
2.125	+ .000/- .002	2.625	+ .003/- .000	0.413	2.126	+ .003/- .000	4300BD25002125N375
2.250	+ .000/- .002	2.750	+ .003/- .000	0.413	2.251	+ .003/- .000	4300BD25002250N375
2.375	+ .000/- .002	2.875	+ .003/- .000	0.413	2.376	+ .003/- .000	4300BD25002375N375
2.500	+ .000/- .002	3.000	+ .003/- .000	0.413	2.501	+ .003/- .000	4300BD25002500N375
2.625	+ .000/- .002	3.125	+ .003/- .000	0.413	2.626	+ .003/- .000	4300BD25002625N375
2.750	+ .000/- .002	3.250	+ .003/- .000	0.413	2.751	+ .003/- .000	4300BD25002750N375
3.000	+ .000/- .002	3.500	+ .003/- .000	0.413	3.001	+ .003/- .000	4300BD25003000N375
3.250	+ .000/- .002	3.750	+ .003/- .000	0.413	3.251	+ .003/- .000	4300BD25003250N375
3.500	+ .000/- .002	4.125	+ .004/- .000	0.550	3.502	+ .003/- .000	4300BD31203500N500
3.750	+ .000/- .002	4.375	+ .004/- .000	0.550	3.752	+ .003/- .000	4300BD31203750N500
4.000	+ .000/- .002	4.625	+ .004/- .000	0.550	4.002	+ .003/- .000	4300BD31204000N500
4.250	+ .000/- .002	4.875	+ .004/- .000	0.550	4.252	+ .003/- .000	4300BD31204250N500
4.500	+ .000/- .002	5.125	+ .004/- .000	0.550	4.502	+ .003/- .000	4300BD31204500N500
4.750	+ .000/- .002	5.375	+ .004/- .000	0.550	4.752	+ .003/- .000	4300BD31204750N500
5.000	+ .000/- .002	5.750	+ .005/- .000	0.688	5.002	+ .004/- .000	4300BD37505000N625

*If used with wear rings, refer to wear ring throat diameter.

Above table reflects recommended cross-sections for rod diameters shown. Alternate cross-sections and additional sizes may be considered. Consult your Parker representative for assistance.



BD Profile

ROD GLAND DIMENSIONS – BD Profile – Inch (cont'd)

Hardware Dimensions							Part Number
A Rod Diameter		B Groove Diameter		C Groove Width	D Throat Diameter*		
Dia.	Tol.	Dia.	Tol.	+ .015/- .000	Dia.	Tol.	
5.500	+ .000/- .002	6.250	+ .005/- .000	0.688	5.502	+ .004/- .000	4300BD37505500N625
6.000	+ .000/- .002	6.750	+ .005/- .000	0.688	6.002	+ .004/- .000	4300BD37506000N625
6.500	+ .000/- .002	7.250	+ .005/- .000	0.688	6.502	+ .004/- .000	4300BD37506500N625
7.000	+ .000/- .002	7.750	+ .005/- .000	0.688	7.002	+ .004/- .000	4300BD37507000N625
7.500	+ .000/- .003	8.500	+ .007/- .000	0.825	7.502	+ .005/- .000	4300BD50007500N750
8.000	+ .000/- .003	9.000	+ .007/- .000	0.825	8.002	+ .005/- .000	4300BD50008000N750
8.500	+ .000/- .003	9.500	+ .007/- .000	0.825	8.502	+ .005/- .000	4300BD50008500N750
9.000	+ .000/- .003	10.000	+ .007/- .000	0.825	9.002	+ .005/- .000	4300BD50009000N750
9.500	+ .000/- .003	10.500	+ .007/- .000	0.825	9.502	+ .005/- .000	4300BD50009500N750
10.000	+ .000/- .003	11.000	+ .007/- .000	0.825	10.002	+ .005/- .000	4300BD50010000N750

*If used with wear rings, refer to wear ring throat diameter.

Above table reflects recommended cross-sections for rod diameters shown. Alternate cross-sections and additional sizes may be considered. Consult your Parker representative for assistance.



BD with Back-up Profile

For enhanced extrusion protection, Parker offers the BD profile with a positively actuated back-up ring located in the heel. The O-ring energizer functions as a spring to maintain sealing contact under low pressure or vacuum applications. The knife trimmed, beveled lip does an excellent job wiping fluid film. A stabilizing lip is located below the primary sealing lip, just above the base of the seal, to provide enhanced sealing performance and ensure a tight, stable fit in the gland.

The standard material for the BD with back-up profile is Parker's P5065 polyurethane and W4655 Moly filled Nylon back-up ring.

The BD profile is designed to be used as a stand alone rod seal or for use with the BR profile buffer seal for more critical sealing applications.

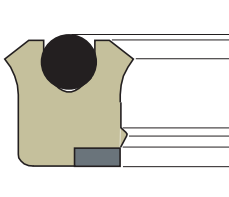
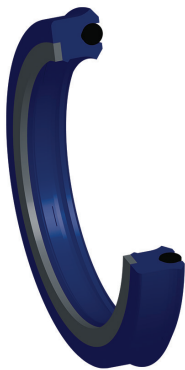

**BD with Back-up
Cross-Section**

- O-ring energized lip seal
- Excellent sealing under low/zero pressure conditions
- Beveled sealing lip
- Rectangular cross section and secondary lip in heel ensure stability in the gland
- Positively actuated back-up ring enhances extrusion resistance
- P5065 Low temp polyurethane

RANGE OF APPLICATION

Standard Material

Elastomer	Back-up	Energizer
P5065A88	W4655	Y, Low Temp Nitrile
Temperature	Pressure*	Speed
-65°F to +200°F (-54°C to +93°C)	10000 psi (688 bar)	< 1.6 ft/s (0.5 m/s)

**Pressure Range without wear rings. If used with wear rings, refer to the Engineering Section in Catalog EPS 5370.*

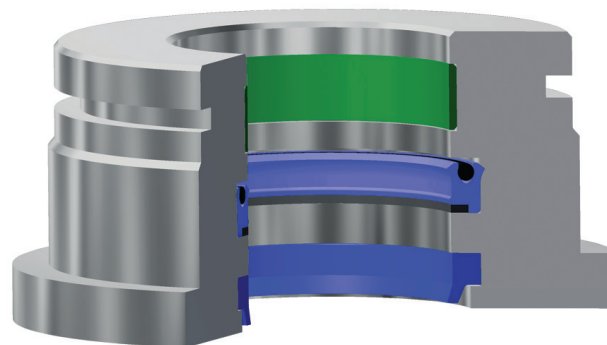

BD Installed in Rod Gland

BD with Back-up Profile

PART NUMBER NOMENCLATURE

BD with Back-up Profile — Inch

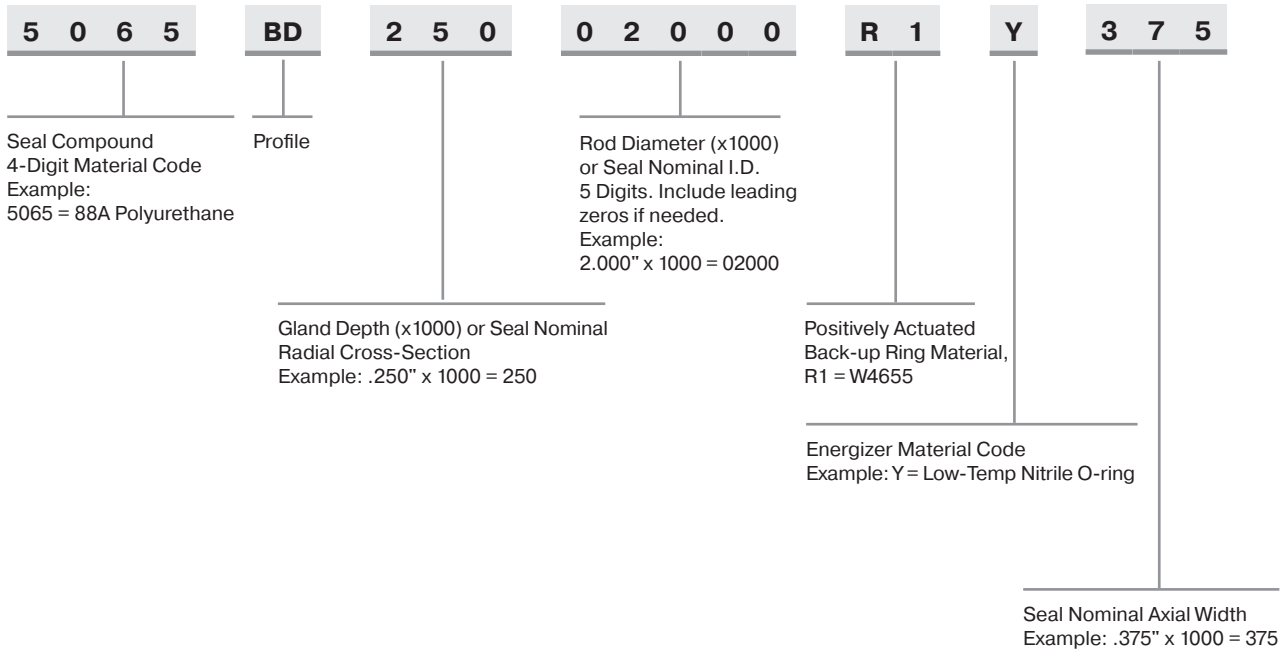

GLAND DIMENSIONS — BD with Back-up Profile

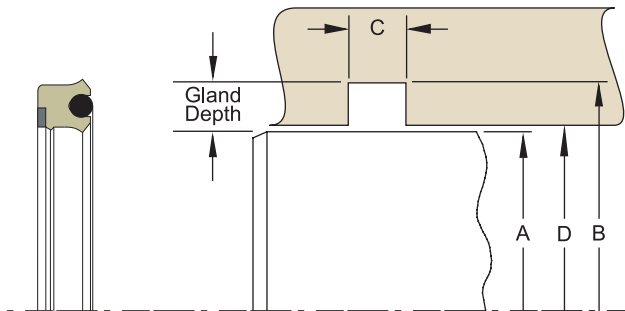

Please refer to the [Engineering Section](#) for surface finish and additional hardware considerations.

GLAND DIMENSIONS — BD with Back-up Profile — Inch

Hardware Dimensions							Part Number
A Rod Diameter		B Groove Diameter		C Groove Width	D Throat Diameter*		
Dia.	Tol.	Dia.	Tol.	+ .015/- .000	Dia.	Tol.	
0.250	+ .000/- .001	0.500	+ .002/- .000	0.206	0.251	+ .002/- .000	5065BD12500250R1Y187
0.312	+ .000/- .001	0.562	+ .002/- .000	0.206	0.313	+ .002/- .000	5065BD12500312R1Y187
0.375	+ .000/- .001	0.625	+ .002/- .000	0.206	0.376	+ .002/- .000	5065BD12500375R1Y187
0.437	+ .000/- .001	0.687	+ .002/- .000	0.206	0.438	+ .002/- .000	5065BD12500437R1Y187
0.500	+ .000/- .001	0.750	+ .002/- .000	0.206	0.501	+ .002/- .000	5065BD12500500R1Y187
0.625	+ .000/- .001	0.875	+ .002/- .000	0.275	0.626	+ .002/- .000	5065BD12500625R1Y250
0.750	+ .000/- .001	1.000	+ .002/- .000	0.275	0.751	+ .002/- .000	5065BD12500750R1Y250
0.875	+ .000/- .001	1.125	+ .002/- .000	0.275	0.876	+ .002/- .000	5065BD12500875R1Y250
1.000	+ .000/- .002	1.375	+ .002/- .000	0.343	1.001	+ .002/- .000	5065BD18701000R1Y312
1.125	+ .000/- .002	1.500	+ .002/- .000	0.343	1.126	+ .002/- .000	5065BD18701125R1Y312
1.250	+ .000/- .002	1.625	+ .002/- .000	0.343	1.251	+ .002/- .000	5065BD18701250R1Y312
1.375	+ .000/- .002	1.750	+ .002/- .000	0.343	1.376	+ .002/- .000	5065BD18701375R1Y312
1.500	+ .000/- .002	1.875	+ .002/- .000	0.413	1.501	+ .002/- .000	5065BD18701500R1Y375
1.625	+ .000/- .002	2.000	+ .002/- .000	0.413	1.626	+ .002/- .000	5065BD18701625R1Y375
1.750	+ .000/- .002	2.125	+ .002/- .000	0.413	1.751	+ .002/- .000	5065BD18701750R1Y375
1.875	+ .000/- .002	2.250	+ .002/- .000	0.413	1.876	+ .002/- .000	5065BD18701875R1Y375
2.000	+ .000/- .002	2.500	+ .003/- .000	0.413	2.001	+ .003/- .000	5065BD25002000R1Y375
2.125	+ .000/- .002	2.625	+ .003/- .000	0.413	2.126	+ .003/- .000	5065BD25002125R1Y375
2.250	+ .000/- .002	2.750	+ .003/- .000	0.413	2.251	+ .003/- .000	5065BD25002250R1Y375
2.375	+ .000/- .002	2.875	+ .003/- .000	0.413	2.376	+ .003/- .000	5065BD25002375R1Y375
2.500	+ .000/- .002	3.000	+ .003/- .000	0.413	2.501	+ .003/- .000	5065BD25002500R1Y375
2.625	+ .000/- .002	3.125	+ .003/- .000	0.413	2.626	+ .003/- .000	5065BD25002625R1Y375
2.750	+ .000/- .002	3.250	+ .003/- .000	0.413	2.751	+ .003/- .000	5065BD25002750R1Y375
3.000	+ .000/- .002	3.500	+ .003/- .000	0.413	3.001	+ .003/- .000	5065BD25003000R1Y375
3.250	+ .000/- .002	3.750	+ .003/- .000	0.413	3.251	+ .003/- .000	5065BD25003250R1Y375
3.500	+ .000/- .002	4.125	+ .004/- .000	0.550	3.502	+ .003/- .000	5065BD31203500R1Y500

*If used with wear rings, refer to wear ring throat diameter.

Above table reflects recommended cross-sections for rod diameters shown. Alternate cross-sections and additional sizes may be considered. Consult your Parker representative for assistance



BD with Back-up Profile

GLAND DIMENSIONS – BD with Back-up Profile – Inch (cont'd)

Hardware Dimensions							Part Number
A Rod Diameter		B Groove Diameter		C Groove Width	D Throat Diameter*		
Dia.	Tol.	Dia.	Tol.	+ .015/- .000	Dia.	Tol.	
3.750	+ .000/- .002	4.375	+ .004/- .000	0.550	3.752	+ .003/- .000	5065BD31203750R1Y500
4.000	+ .000/- .002	4.625	+ .004/- .000	0.550	4.002	+ .003/- .000	5065BD31204000R1Y500
4.250	+ .000/- .002	4.875	+ .004/- .000	0.550	4.252	+ .003/- .000	5065BD31204250R1Y500
4.500	+ .000/- .002	5.125	+ .004/- .000	0.550	4.502	+ .003/- .000	5065BD31204500R1Y500
4.750	+ .000/- .002	5.375	+ .004/- .000	0.550	4.752	+ .003/- .000	5065BD31204750R1Y500
5.000	+ .000/- .002	5.750	+ .005/- .000	0.688	5.002	+ .004/- .000	5065BD37505000R1Y625
5.500	+ .000/- .002	6.250	+ .005/- .000	0.688	5.502	+ .004/- .000	5065BD37505500R1Y625
6.000	+ .000/- .002	6.750	+ .005/- .000	0.688	6.002	+ .004/- .000	5065BD37506000R1Y625
6.500	+ .000/- .002	7.250	+ .005/- .000	0.688	6.502	+ .004/- .000	5065BD37506500R1Y625
7.000	+ .000/- .002	7.750	+ .005/- .000	0.688	7.002	+ .004/- .000	5065BD37507000R1Y625
7.500	+ .000/- .003	8.500	+ .007/- .000	0.825	7.502	+ .005/- .000	5065BD50007500R1Y750
8.000	+ .000/- .003	9.000	+ .007/- .000	0.825	8.002	+ .005/- .000	5065BD50008000R1Y750
8.500	+ .000/- .003	9.500	+ .007/- .000	0.825	8.502	+ .005/- .000	5065BD50008500R1Y750
9.000	+ .000/- .003	10.000	+ .007/- .000	0.825	9.002	+ .005/- .000	5065BD50009000R1Y750
9.500	+ .000/- .003	10.500	+ .007/- .000	0.825	9.502	+ .005/- .000	5065BD50009500R1Y750
10.000	+ .000/- .003	11.000	+ .007/- .000	0.825	10.002	+ .005/- .000	5065BD50010000R1Y750

Hardware Dimensions							Part Number
A Rod Diameter		B Groove Diameter		C Groove Width	D Throat Diameter*		
Dia.	Tol.	Dia.	Tol.	+ .015/- .000	Dia.	Tol.	
5.500	+ .000/- .002	6.250	+ .005/- .000	0.688	5.502	+ .004/- .000	5065BD37505500R1Y625
6.000	+ .000/- .002	6.750	+ .005/- .000	0.688	6.002	+ .004/- .000	5065BD37506000R1Y625
6.500	+ .000/- .002	7.250	+ .005/- .000	0.688	6.502	+ .004/- .000	5065BD37506500R1Y625
7.000	+ .000/- .002	7.750	+ .005/- .000	0.688	7.002	+ .004/- .000	5065BD37507000R1Y625
7.500	+ .000/- .003	8.500	+ .007/- .000	0.825	7.502	+ .005/- .000	5065BD50007500R1Y750
8.000	+ .000/- .003	9.000	+ .007/- .000	0.825	8.002	+ .005/- .000	5065BD50008000R1Y750
8.500	+ .000/- .003	9.500	+ .007/- .000	0.825	8.502	+ .005/- .000	5065BD50008500R1Y750
9.000	+ .000/- .003	10.000	+ .007/- .000	0.825	9.002	+ .005/- .000	5065BD50009000R1Y750
9.500	+ .000/- .003	10.500	+ .007/- .000	0.825	9.502	+ .005/- .000	5065BD50009500R1Y750
10.000	+ .000/- .003	11.000	+ .007/- .000	0.825	10.002	+ .005/- .000	5065BD50010000R1Y750

*If used with wear rings, refer to wear ring throat diameter.

Above table reflects recommended cross-sections for rod diameters shown. Alternate cross-sections and additional sizes may be considered. Consult your Parker representative for assistance



BR Profile

The BR profile is a compact rod seal designed to act as a buffer seal for the primary rod seal. As a buffer seal, the BR profile provides the majority of the rod sealing performance. Any fluid located between the BR profile and the rod seal will relieve back into the cylinder by flowing past the BR profile's flexible static side lip and slotted pedestals. This relieving, or check valve function, allows the BR profile and primary rod seal to work as a sealing system without danger of developing a pressure trap. As a sealing system, the BR profile and primary rod seal provide optimal performance in the most difficult applications. The standard material for the BR profile is Parker's P4300 polyurethane and W4655 Moly-filled Nylon back-up ring.

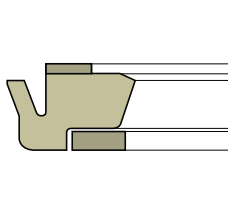
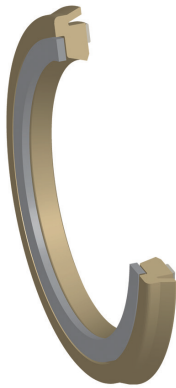

BR Profile Cross-Section

- Long-wearing, buffer seal with back-up
- Premium Resilon® polyurethane
- Extrusion resistant nylon back-up ring
- Flexible static side lip regulates pressure between buffer ring and rod seal
- Slotted pedestals allow checkvalve-type fluid movement
- When used in combination with primary rod seal, functions as pressure spike suppressor

RANGE OF APPLICATION

Standard Material

Elastomer
P4300A90

Positively Actuated

Back-up
W4655

Temperature
-65°F to +275°F
(-54°C to +135°C)

Pressure*
10000 psi
(688 bar)

Speed
< 1.6 ft/s
(0.5 m/s)

**Pressure Range without wear rings. If used with wear rings, refer to the Engineering Section in Catalog EPS 5370.*

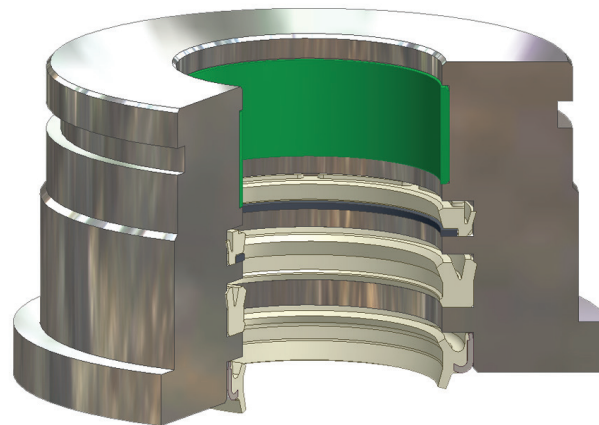

BR Installed in Rod Gland

BR Profile

PART NUMBER NOMENCLATURE

BR Profile — Inch

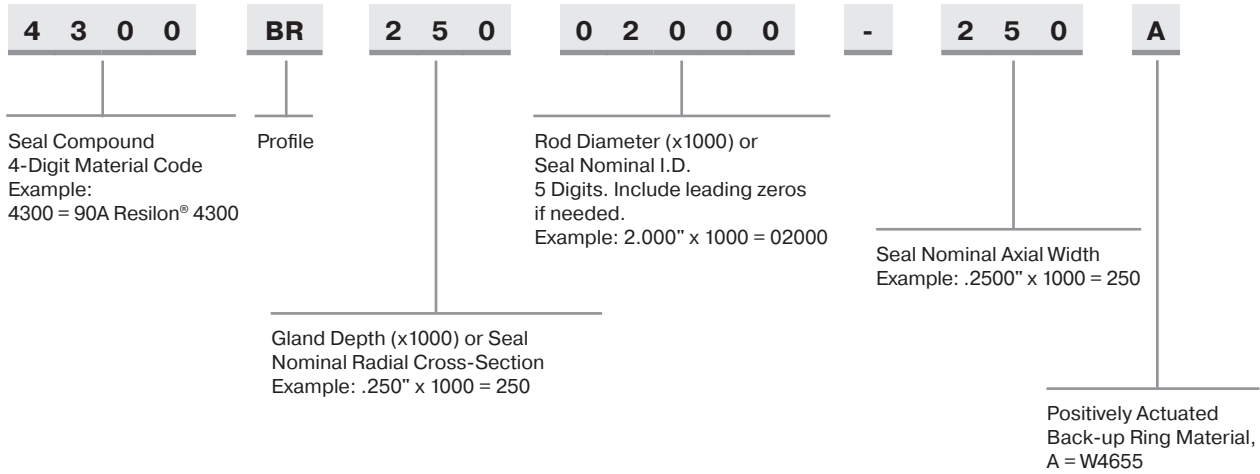

GLAND DIMENSIONS — BR Profile

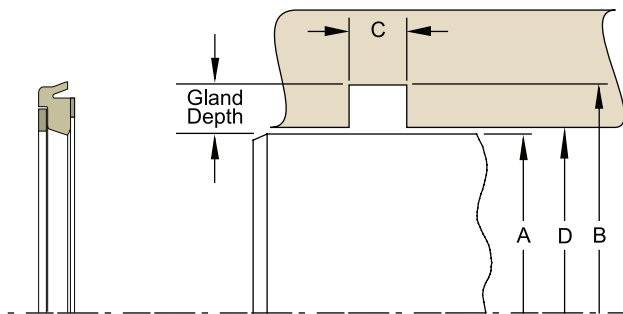

Please refer to the [Engineering Section](#) for surface finish and additional hardware considerations.

BR Profile

GLAND DIMENSIONS — BR Profile — Inch

Hardware Dimensions							Part Number
A Rod Diameter		B Groove Diameter		C Groove Width	D Throat Diameter*		
Dia.	Tol.	Dia.	Tol.	+ .015/- .000	Dia.	Tol.	
0.250	+ .000/- .001	0.500	+ .002/- .000	0.138	0.251	+ .002/- .000	4300BR12500250-125A
0.312	+ .000/- .001	0.562	+ .002/- .000	0.138	0.313	+ .002/- .000	4300BR12500312-125A
0.375	+ .000/- .001	0.625	+ .002/- .000	0.138	0.376	+ .002/- .000	4300BR12500375-125A
0.437	+ .000/- .001	0.687	+ .002/- .000	0.138	0.438	+ .002/- .000	4300BR12500437-125A
0.500	+ .000/- .001	0.750	+ .002/- .000	0.138	0.501	+ .002/- .000	4300BR12500500-125A
0.625	+ .000/- .001	0.875	+ .002/- .000	0.138	0.626	+ .002/- .000	4300BR12500625-125A
0.750	+ .000/- .001	1.000	+ .002/- .000	0.138	0.751	+ .002/- .000	4300BR12500750-125A
0.875	+ .000/- .001	1.125	+ .002/- .000	0.138	0.876	+ .002/- .000	4300BR12500875-125A
1.000	+ .000/- .002	1.375	+ .002/- .000	0.206	1.001	+ .002/- .000	4300BR18701000-187A
1.125	+ .000/- .002	1.500	+ .002/- .000	0.206	1.126	+ .002/- .000	4300BR18701125-187A
1.250	+ .000/- .002	1.625	+ .002/- .000	0.206	1.251	+ .002/- .000	4300BR18701250-187A
1.375	+ .000/- .002	1.750	+ .002/- .000	0.206	1.376	+ .002/- .000	4300BR18701375-187A
1.500	+ .000/- .002	1.875	+ .002/- .000	0.206	1.501	+ .002/- .000	4300BR18701500-187A
1.625	+ .000/- .002	2.000	+ .002/- .000	0.206	1.626	+ .002/- .000	4300BR18701625-187A
1.750	+ .000/- .002	2.125	+ .002/- .000	0.206	1.751	+ .002/- .000	4300BR18701750-187A
1.875	+ .000/- .002	2.250	+ .002/- .000	0.206	1.876	+ .002/- .000	4300BR18701875-187A

*If used with wear rings, refer to wear ring throat diameter.

Above table reflects recommended cross-sections for rod diameters shown. Alternate cross-sections and additional sizes may be considered. Consult your Parker representative for assistance



BR Profile

GLAND DIMENSIONS — BR Profile — Inch (cont'd)

Hardware Dimensions							Part Number
A Rod Diameter		B Groove Diameter		C Groove Width	D Throat Diameter*		
Dia.	Tol.	Dia.	Tol.	+ .015/- .000	Dia.	Tol.	
2.000	+ .000/- .002	2.500	+ .003/- .000	0.275	2.001	+ .003/- .000	4300BR25002000-250A
2.125	+ .000/- .002	2.625	+ .003/- .000	0.275	2.126	+ .003/- .000	4300BR25002125-250A
2.250	+ .000/- .002	2.750	+ .003/- .000	0.275	2.251	+ .003/- .000	4300BR25002250-250A
2.375	+ .000/- .002	2.875	+ .003/- .000	0.275	2.376	+ .003/- .000	4300BR25002375-250A
2.500	+ .000/- .002	3.000	+ .003/- .000	0.275	2.501	+ .003/- .000	4300BR25002500-250A
2.625	+ .000/- .002	3.125	+ .003/- .000	0.275	2.626	+ .003/- .000	4300BR25002625-250A
2.750	+ .000/- .002	3.250	+ .003/- .000	0.275	2.751	+ .003/- .000	4300BR25002750-250A
3.000	+ .000/- .002	3.500	+ .003/- .000	0.275	3.001	+ .003/- .000	4300BR25003000-250A
3.250	+ .000/- .002	3.750	+ .003/- .000	0.275	3.251	+ .003/- .000	4300BR25003250-250A
3.500	+ .000/- .002	4.125	+ .004/- .000	0.343	3.502	+ .003/- .000	4300BR31203500-312A
3.750	+ .000/- .002	4.375	+ .004/- .000	0.343	3.752	+ .003/- .000	4300BR31203750-312A
4.000	+ .000/- .002	4.625	+ .004/- .000	0.343	4.002	+ .003/- .000	4300BR31204000-312A
4.250	+ .000/- .002	4.875	+ .004/- .000	0.343	4.252	+ .003/- .000	4300BR31204250-312A
4.500	+ .000/- .002	5.125	+ .004/- .000	0.343	4.502	+ .003/- .000	4300BR31204500-312A
4.750	+ .000/- .002	5.375	+ .004/- .000	0.343	4.752	+ .003/- .000	4300BR31204750-312A
5.000	+ .000/- .002	5.750	+ .005/- .000	0.413	5.002	+ .004/- .000	4300BR37505000-375A

*If used with wear rings, refer to wear ring throat diameter.

Above table reflects recommended cross-sections for rod diameters shown. Alternate cross-sections and additional sizes may be considered. Consult your Parker representative for assistance



BR Profile

GLAND DIMENSIONS — BR Profile — Inch (cont'd)

Hardware Dimensions							Part Number
A Rod Diameter		B Groove Diameter		C Groove Width	D Throat Diameter*		
Dia.	Tol.	Dia.	Tol.	+ .015/- .000	Dia.	Tol.	
5.500	+ .000/- .002	6.250	+ .005/- .000	0.413	5.502	+ .004/- .000	4300BR37505500-375A
6.000	+ .000/- .002	6.750	+ .005/- .000	0.413	6.002	+ .004/- .000	4300BR37506000-375A
6.500	+ .000/- .002	7.250	+ .005/- .000	0.413	6.502	+ .004/- .000	4300BR37506500-375A
7.000	+ .000/- .002	7.750	+ .005/- .000	0.413	7.002	+ .004/- .000	4300BR37507000-375A
7.500	+ .000/- .003	8.500	+ .007/- .000	0.550	7.502	+ .005/- .000	4300BR50007500-500A
8.000	+ .000/- .003	9.000	+ .007/- .000	0.550	8.002	+ .005/- .000	4300BR50008000-500A
8.500	+ .000/- .003	9.500	+ .007/- .000	0.550	8.502	+ .005/- .000	4300BR50008500-500A
9.000	+ .000/- .003	10.000	+ .007/- .000	0.550	9.002	+ .005/- .000	4300BR50009000-500A
9.500	+ .000/- .003	10.500	+ .007/- .000	0.550	9.502	+ .005/- .000	4300BR50009500-500A
10.000	+ .000/- .003	11.000	+ .007/- .000	0.550	10.002	+ .005/- .000	4300BR50010000-500A

*If used with wear rings, refer to wear ring throat diameter.

Above table reflects recommended cross-sections for rod diameters shown. Alternate cross-sections and additional sizes may be considered. Consult your Parker representative for assistance



Parker piston seal profiles represent the latest in advanced sealing technology for today's fluid power equipment. The combination of optimized geometry and high performance material results in highly engineered designs that offer the best possible solution for long life and improved performance.

PISTON SEAL PROFILES

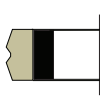
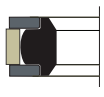
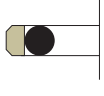
Profile	Cross Section	Description	Pressure Max* psi	Standard Material		Page
				4304	0401	
Piston Seal Decision Tree						34
BP		Premium TPU cap piston seal	7000	•		35
CT		Premium PTFE cap piston seal with Nylon back-up rings	10000		•	38
OE		Compact PTFE cap piston seal	5000		•	42

*Max pressure without wear rings. See profile detail page for max pressure when using wear rings.

Piston Seal Decision Tree

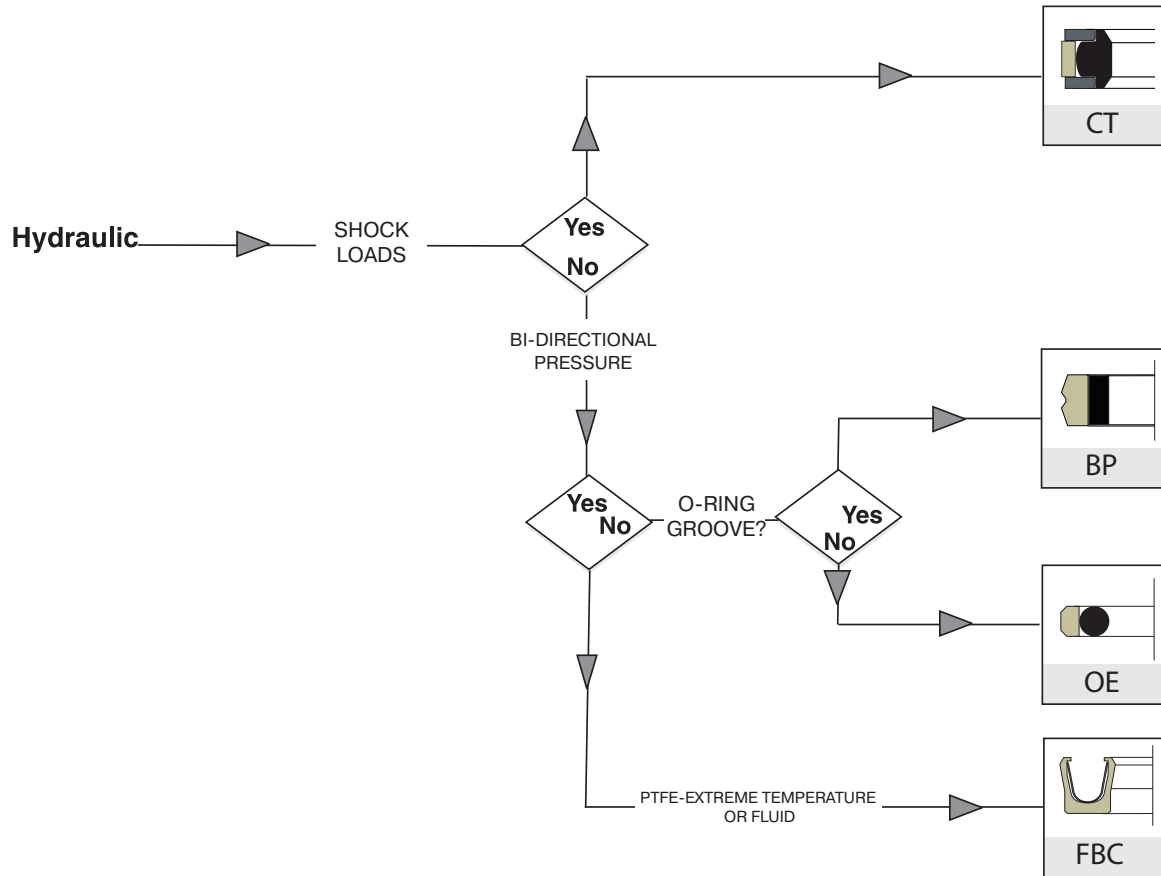

BP Profile

Parker's BP profile is a squeeze type, bi-directional piston seal for use in medium to heavy duty hydraulic applications. This premium polyurethane cap seal is primarily designed for linear applications but has been successfully used as a low speed rotary seal. The standard material for this profile is Resilon® 4304 polyurethane, offering higher wear resistance, extrusion resistance, and extended temperature range. The Resilon® 4304 cap is energized using a resilient nitrile elastomer offering low compression set. The BP profile's geometry provides a fluid reservoir between the two sealing lips which holds system fluid, resulting in reduced breakaway and running friction. Standard BP profile is designed to retrofit industrial reciprocating O-ring grooves. The BP profile is easy to install and will resist rolling and twisting in long stroke applications.

Sold only as an assembly (seal and energizer).

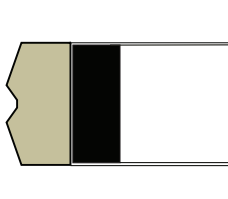
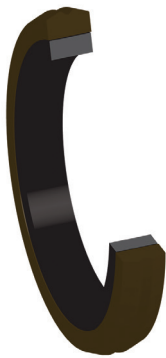

BP Cross-Section

RANGE OF APPLICATION

Standard Material*

Cap P4304D60	Energizer A, 70A Nitrile	
Temperature -65°F to +275°F (-54°C to +135°C)	Pressure* 7000 psi (482 bar)	Speed < 1.6 ft/s (0.5 m/s)

*Pressure Range without wear rings. If used with wear rings, refer to the Engineering Section in Catalog EPS 5370.

- Premium Resilon® 4304 polyurethane cap material
- Extended life, wear-resistant, extrusion resistant polyurethane
- Positive sealing points with lubrication pocket
- Non-drift seal performance with lower friction than dual seals
- Low compression set
- Easy to Install
- Retrofits O-ring grooves
- Resists rolling and twisting over long strokes

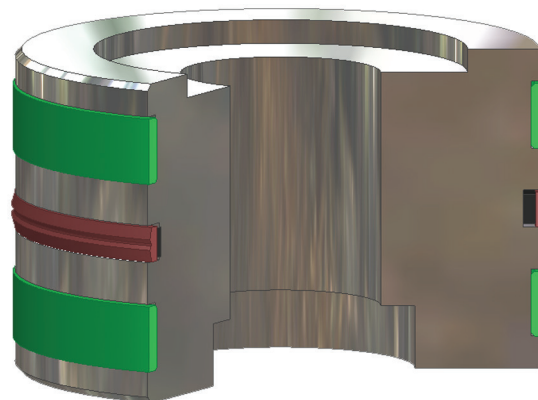

BP Installed in Piston Gland



BP Profile

PART NUMBER NOMENCLATURE

BP Profile — Inch

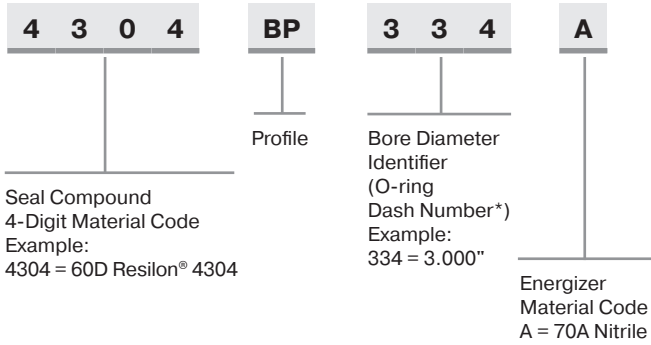

GLAND DIMENSIONS — BP Profile

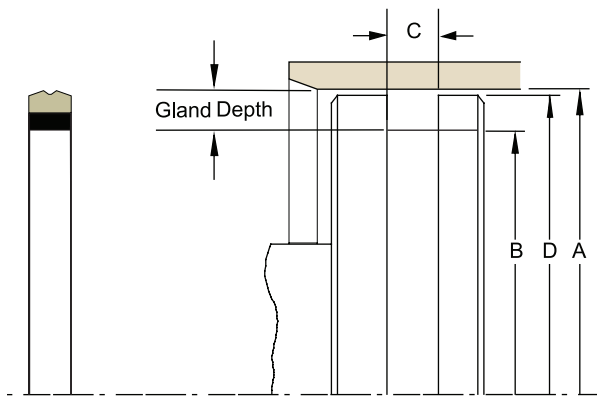

Please refer to the [Engineering Section](#) for surface finish and additional hardware considerations.

BP Profile

PISTON GLAND DIMENSIONS — BP Profile — Inch

Hardware Dimensions							Part Number
A Bore Diameter		B Groove Diameter		C Groove Width	D Piston Diameter*		
Dia.	Tol.	Dia.	Tol.	+ .005/- .000	Dia.	Tol.	
1.500	+ .002/- .000	1.258	+ .000/- .002	0.187	1.497	+ .000/- .001	4304BP218A
1.625	+ .002/- .000	1.383	+ .000/- .002	0.187	1.622	+ .000/- .001	4304BP220A
1.750	+ .002/- .000	1.508	+ .000/- .002	0.187	1.747	+ .000/- .001	4304BP222A
2.000	+ .002/- .000	1.630	+ .000/- .002	0.281	1.997	+ .000/- .001	4304BP326A
2.250	+ .002/- .000	1.880	+ .000/- .002	0.281	2.247	+ .000/- .001	4304BP328A
2.500	+ .002/- .000	2.130	+ .000/- .002	0.281	2.497	+ .000/- .001	4304BP330A
2.750	+ .002/- .000	2.380	+ .000/- .002	0.281	2.747	+ .000/- .001	4304BP332A
3.000	+ .002/- .000	2.630	+ .000/- .002	0.281	2.997	+ .000/- .001	4304BP334A
3.250	+ .002/- .000	2.880	+ .000/- .002	0.281	3.247	+ .000/- .001	4304BP336A
3.500	+ .002/- .000	3.130	+ .000/- .002	0.281	3.497	+ .000/- .001	4304BP338A
3.750	+ .002/- .000	3.380	+ .000/- .002	0.281	3.747	+ .000/- .001	4304BP340A
4.000	+ .002/- .000	3.630	+ .000/- .002	0.281	3.997	+ .000/- .001	4304BP342A
4.250	+ .002/- .000	3.880	+ .000/- .002	0.281	4.247	+ .000/- .001	4304BP344A
4.500	+ .002/- .000	4.130	+ .000/- .002	0.281	4.497	+ .000/- .001	4304BP346A
4.750	+ .002/- .000	4.380	+ .000/- .002	0.281	4.747	+ .000/- .001	4304BP348A
5.000	+ .002/- .000	4.630	+ .000/- .002	0.281	4.997	+ .000/- .001	4304BP350A
5.252	+ .002/- .000	4.778	+ .000/- .002	0.375	5.248	+ .000/- .001	4304BP427A
5.502	+ .002/- .000	5.028	+ .000/- .002	0.375	5.498	+ .000/- .001	4304BP429A
5.752	+ .002/- .000	5.278	+ .000/- .002	0.375	5.748	+ .000/- .001	4304BP431A
6.002	+ .002/- .000	5.528	+ .000/- .002	0.375	5.998	+ .000/- .001	4304BP433A
6.502	+ .002/- .000	6.028	+ .000/- .002	0.375	6.498	+ .000/- .001	4304BP437A
7.002	+ .002/- .000	6.528	+ .000/- .002	0.375	6.998	+ .000/- .001	4304BP439A
7.502	+ .002/- .000	7.028	+ .000/- .002	0.375	7.498	+ .000/- .001	4304BP441A
8.002	+ .002/- .000	7.528	+ .000/- .002	0.375	7.998	+ .000/- .001	4304BP443A

*If used with wear rings, refer to wear ring piston diameter.

Above table reflects recommended cross-sections for bore diameters shown. Alternate cross-sections and additional sizes may be considered. Consult your Parker representative for assistance.



CT Profile

The Parker CT profile is a robust design for heavy duty hydraulic applications and is an excellent choice for sealing mobile hydraulic applications that experience shock loads. This four piece profile is an assembly comprised of a rubber energizer, PTFE cap and two back-up rings. In application, fluid pressure forces the rubber energizer to apply increased load against the PTFE cap and back-up rings. This results in increased sealing force against the bore and allows the back-up rings to close off the extrusion gap between the piston and the bore. Once activated by pressure, the back-up rings protect the seal from extruding and keep internal contamination away from the PTFE cap. Parker's CT profile will retrofit non-Parker seals of similar design.

The CT Profile is sold only as an assembly.

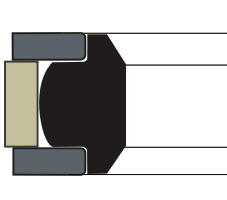
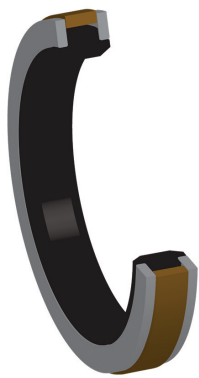

CT Cross-Section

- Seals to 10000 psi (688 bar)
- Extrusion resistant
- Resists shock load failure
- Low breakaway force
- Dynamic, smooth motion
- No-drift seal performance

RANGE OF APPLICATION

Standard Material

Cap	Energizer	Back-up Rings
0401 40% bronze-filled PTFE	A, 70A Nitrile	A, Moly-filled Nylon

Temperature*	Pressure**	Speed
-30°F to +250°F (-34°C to +121°C)	10000 psi (688 bar)	< 5 ft/s (1.5 m/s)

*The temperature range of the CT profile is limited to the thermal capability of the energizer. A wider temperature range can be achieved by using alternate energizer and back-up ring compounds.

**Pressure Range without wear rings. If used with wear rings, refer to the Engineering Section in Catalog EPS 5370.

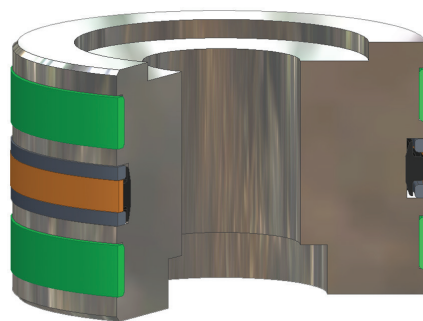

CT installed in Piston Gland

CT Profile

PART NUMBER NOMENCLATURE
CT Profile – Inch

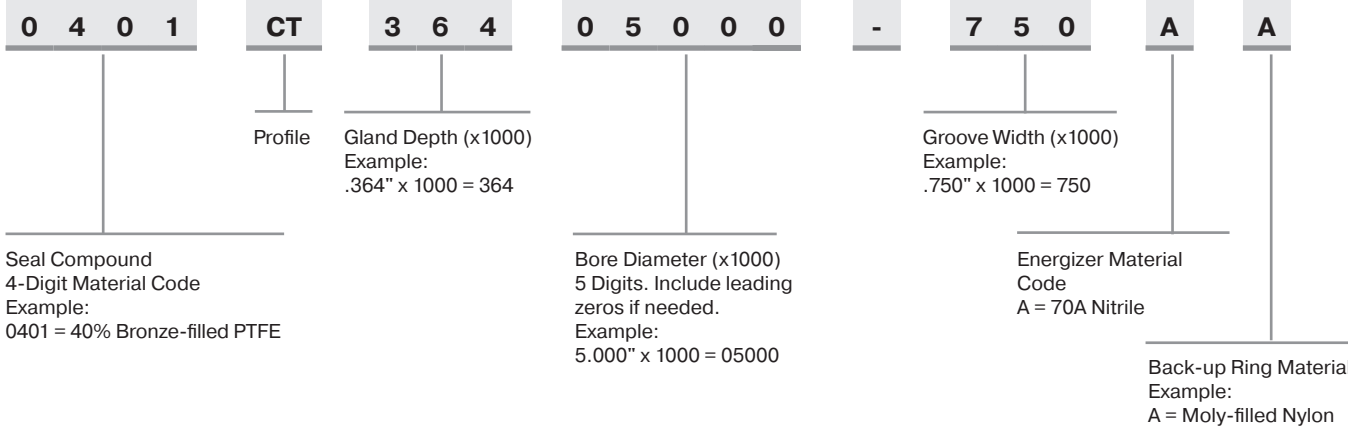

GLAND DIMENSIONS – CT Profile

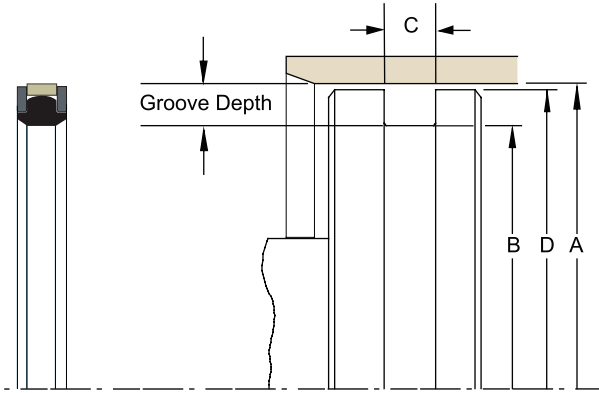

Please refer to the [Engineering Section](#) for surface finish and additional hardware considerations.



CT Profile

PISTON GLAND DIMENSIONS (Standard Style) — CT Profile — Inch

A Bore Diameter		B Groove Diameter		C Groove Width	D Piston Diameter*		Part Number (Standard Style)
Dia.	Tol.	Dia.	Tol.	+ .010/- .000	Dia.	Tol.	
1.000	+ .002/- .000	0.628	+ .000/- .002	0.424	0.999	+ .000/- .002	0401CT18601000-424AA
1.063	+ .002/- .000	0.691	+ .000/- .002	0.424	1.062	+ .000/- .002	0401CT18601063-424AA
1.125	+ .002/- .000	0.753	+ .000/- .002	0.424	1.124	+ .000/- .002	0401CT18601125-424AA
1.188	+ .002/- .000	0.816	+ .000/- .002	0.424	1.187	+ .000/- .002	0401CT18601188-424AA
1.250	+ .002/- .000	0.878	+ .000/- .002	0.424	1.249	+ .000/- .002	0401CT18601250-424AA
1.313	+ .002/- .000	0.941	+ .000/- .002	0.424	1.312	+ .000/- .002	0401CT18601313-424AA
1.375	+ .002/- .000	1.003	+ .000/- .002	0.424	1.374	+ .000/- .002	0401CT18601375-424AA
1.438	+ .002/- .000	1.066	+ .000/- .002	0.424	1.437	+ .000/- .002	0401CT18601438-424AA
1.500	+ .002/- .000	1.128	+ .000/- .002	0.424	1.499	+ .000/- .002	0401CT18601500-424AA
1.563	+ .002/- .000	1.191	+ .000/- .002	0.424	1.562	+ .000/- .002	0401CT18601563-424AA
1.625	+ .002/- .000	1.253	+ .000/- .002	0.424	1.624	+ .000/- .002	0401CT18601625-424AA
1.688	+ .002/- .000	1.316	+ .000/- .002	0.424	1.687	+ .000/- .002	0401CT18601688-424AA
1.750	+ .002/- .000	1.378	+ .000/- .002	0.424	1.749	+ .000/- .002	0401CT18601750-424AA
1.875	+ .002/- .000	1.503	+ .000/- .002	0.424	1.874	+ .000/- .002	0401CT18601875-424AA
2.000	+ .003/- .000	1.628	+ .000/- .003	0.424	1.999	+ .000/- .003	0401CT18602000-424AA
2.125	+ .003/- .000	1.753	+ .000/- .003	0.424	2.124	+ .000/- .003	0401CT18602125-424AA
2.250	+ .003/- .000	1.878	+ .000/- .003	0.424	2.249	+ .000/- .003	0401CT18602250-424AA
2.375	+ .003/- .000	2.003	+ .000/- .003	0.424	2.374	+ .000/- .003	0401CT18602375-424AA
2.500	+ .003/- .000	2.128	+ .000/- .003	0.424	2.499	+ .000/- .003	0401CT18602500-424AA
2.625	+ .003/- .000	2.253	+ .000/- .003	0.424	2.624	+ .000/- .003	0401CT18602625-424AA
2.750	+ .003/- .000	2.378	+ .000/- .003	0.424	2.749	+ .000/- .003	0401CT18602750-424AA
2.875	+ .003/- .000	2.503	+ .000/- .003	0.424	2.874	+ .000/- .003	0401CT18602875-424AA
3.000	+ .004/- .000	2.522	+ .000/- .003	0.579	2.998	+ .000/- .003	0401CT23903000-579AA
3.125	+ .004/- .000	2.647	+ .000/- .003	0.579	3.123	+ .000/- .003	0401CT23903125-579AA
3.250	+ .004/- .000	2.772	+ .000/- .003	0.579	3.248	+ .000/- .003	0401CT23903250-579AA
3.375	+ .004/- .000	2.897	+ .000/- .003	0.579	3.373	+ .000/- .003	0401CT23903375-579AA
3.500	+ .004/- .000	3.022	+ .000/- .003	0.579	3.498	+ .000/- .003	0401CT23903500-579AA
3.625	+ .004/- .000	3.147	+ .000/- .003	0.579	3.623	+ .000/- .003	0401CT23903625-579AA
3.750	+ .004/- .000	3.272	+ .000/- .003	0.579	3.748	+ .000/- .003	0401CT23903750-579AA
3.875	+ .004/- .000	3.397	+ .000/- .003	0.579	3.873	+ .000/- .003	0401CT23903875-579AA
4.000	+ .004/- .000	3.522	+ .000/- .003	0.579	3.998	+ .000/- .003	0401CT23904000-579AA
4.125	+ .004/- .000	3.647	+ .000/- .003	0.579	4.123	+ .000/- .003	0401CT23904125-579AA
4.250	+ .004/- .000	3.772	+ .000/- .003	0.579	4.248	+ .000/- .003	0401CT23904250-579AA
4.375	+ .004/- .000	3.897	+ .000/- .003	0.579	4.373	+ .000/- .003	0401CT23904375-579AA
4.500	+ .004/- .000	4.022	+ .000/- .003	0.579	4.498	+ .000/- .003	0401CT23904500-579AA
4.625	+ .004/- .000	4.147	+ .000/- .003	0.579	4.623	+ .000/- .003	0401CT23904625-579AA
4.750	+ .004/- .000	4.272	+ .000/- .003	0.579	4.748	+ .000/- .003	0401CT23904750-579AA
4.875	+ .004/- .000	4.397	+ .000/- .003	0.579	4.873	+ .000/- .003	0401CT23904875-579AA
5.000	+ .004/- .000	4.272	+ .000/- .003	0.750	4.998	+ .000/- .003	0401CT36405000-750AA
5.125	+ .004/- .000	4.397	+ .000/- .003	0.750	5.123	+ .000/- .003	0401CT36405125-750AA
5.250	+ .004/- .000	4.522	+ .000/- .003	0.750	5.248	+ .000/- .003	0401CT36405250-750AA
5.375	+ .004/- .000	4.647	+ .000/- .003	0.750	5.373	+ .000/- .003	0401CT36405375-750AA
5.500	+ .004/- .000	4.772	+ .000/- .004	0.750	5.497	+ .000/- .004	0401CT36405500-750AA
5.625	+ .004/- .000	4.897	+ .000/- .004	0.750	5.622	+ .000/- .004	0401CT36405625-750AA

*If used with wear rings, refer to wear ring piston diameter.

Above table reflects recommended cross-sections for bore diameters shown. Alternate cross-sections and additional sizes may be considered. Consult your Parker representative for assistance.



CT Profile

PISTON GLAND DIMENSIONS (Standard Style) — CT Profile — Inch (cont'd)

A Bore Diameter		B Groove Diameter		C Groove Width	D PistonDiameter*		Part Number (Standard Style)
Dia.	Tol.	Dia.	Tol.	+.010/-.000	Dia.	Tol.	
5.750	+.004/-.000	5.022	+.000/-.004	0.750	5.747	+.000/-.004	0401CT36405750-750AA
5.875	+.004/-.000	5.147	+.000/-.004	0.750	5.872	+.000/-.004	0401CT36405875-750AA
6.000	+.004/-.000	5.272	+.000/-.004	0.750	5.997	+.000/-.004	0401CT36406000-750AA
6.125	+.004/-.000	5.397	+.000/-.004	0.750	6.122	+.000/-.004	0401CT36406125-750AA
6.250	+.004/-.000	5.522	+.000/-.004	0.750	6.247	+.000/-.004	0401CT36406250-750AA
6.375	+.004/-.000	5.647	+.000/-.004	0.750	6.372	+.000/-.004	0401CT36406375-750AA
6.500	+.004/-.000	5.772	+.000/-.004	0.750	6.497	+.000/-.004	0401CT36406500-750AA
6.750	+.004/-.000	6.022	+.000/-.004	0.750	6.747	+.000/-.004	0401CT36406750-750AA
7.000	+.004/-.000	6.272	+.000/-.004	0.750	6.997	+.000/-.004	0401CT36407000-750AA
7.250	+.005/-.000	6.522	+.000/-.004	0.750	7.247	+.000/-.004	0401CT36407250-750AA
7.500	+.005/-.000	6.772	+.000/-.004	0.750	7.497	+.000/-.004	0401CT36407500-750AA
7.750	+.005/-.000	7.022	+.000/-.004	0.750	7.747	+.000/-.004	0401CT36407750-750AA
8.000	+.005/-.000	7.272	+.000/-.005	0.750	7.996	+.000/-.005	0401CT36408000-750AA

*If used with wear rings, refer to wear ring piston diameter.

Above table reflects recommended cross-sections for bore diameters shown. Alternate cross-sections and additional sizes may be considered. Consult your Parker representative for assistance.



OE Profile

The Parker OE profile is a bi-directional piston seal for use in low to medium duty hydraulic applications. The two piece design is comprised of a standard size Parker O-ring energizing a wear resistant PTFE cap. The OE profile offers long wear, low friction and because of its short assembly length requires minimal gland space on the piston. The seal is commonly used in applications such as mobile hydraulics, machine tools, injection molding machines and hydraulic presses. Parker's OE profile will retrofit non-Parker seals of similar design.

The OE profile may be ordered without the energizer by omitting the energizer code.

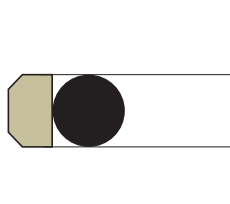

OE Cross-Section

- Long wearing PTFE cap
- Low friction
- Low breakaway force
- Easy to install
- Compact, short assembly length

RANGE OF APPLICATION

Standard Material

Cap

0401 40% bronze-filled PTFE

Energizer

A, 70A Nitrile

Temperature*

-30°F to +250°F
(-34°C to +121°C)

Pressure**

5000 psi
(344 bar)

Speed

< 13 ft/s
(4 m/s)

*The temperature range of the OE profile is limited to the energizer. A wider temperature range can be achieved by using alternate energizer compounds.

**Pressure Range without wear rings. If used with wear rings, refer to the Engineering Section for surface finish and additional hardware considerations.

OPTIONAL (NON-STANDARD) NOTCHED SIDE WALLS:

Adding an "N" to the end of the part number indicates that notches are to be added to the side walls of the PTFE cap. Notches can help optimize the seal's response to fluid pressure by allowing fluid to fill the cavity between the side face of the gland and the seal.

N = Notched walls 

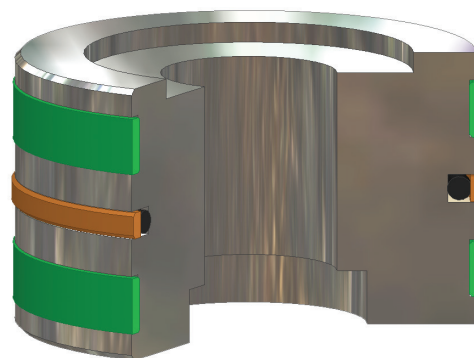

OE installed in Piston Gland



OE Profile

GLAND DIMENSIONS – OE Profile – Inch

A Bore Diameter		B Groove Diameter		C Groove Width	D Piston Diameter*		O-ring Dash Number	Part Number
Dia.	Tol.	Dia.	Tol.	+ .005/- .000	Dia.	Tol.		
0.500	+ .001/- .000	0.326	+ .000/- .001	0.081	0.499	+ .000/- .002	011	0401OE08700500-081A
0.562	+ .001/- .000	0.388	+ .000/- .001	0.081	0.561	+ .000/- .002	012	0401OE08700562-081A
0.625	+ .001/- .000	0.451	+ .000/- .001	0.081	0.624	+ .000/- .002	013	0401OE08700625-081A
0.687	+ .001/- .000	0.513	+ .000/- .001	0.081	0.686	+ .000/- .002	014	0401OE08700687-081A
0.750	+ .001/- .000	0.576	+ .000/- .001	0.081	0.749	+ .000/- .002	015	0401OE08700750-081A
0.812	+ .002/- .000	0.556	+ .000/- .002	0.081	0.811	+ .000/- .002	015	0401OE12800812-081A
0.875	+ .002/- .000	0.619	+ .000/- .002	0.081	0.874	+ .000/- .002	016	0401OE12800875-081A
0.937	+ .002/- .000	0.681	+ .000/- .002	0.081	0.936	+ .000/- .002	017	0401OE12800937-081A
1.000	+ .002/- .000	0.744	+ .000/- .002	0.081	0.999	+ .000/- .002	018	0401OE12801000-081A
1.062	+ .002/- .000	0.806	+ .000/- .002	0.081	1.061	+ .000/- .002	019	0401OE12801062-081A
1.125	+ .002/- .000	0.869	+ .000/- .002	0.081	1.124	+ .000/- .002	020	0401OE12801125-081A
1.187	+ .002/- .000	0.889	+ .000/- .003	0.126	1.186	+ .000/- .002	118	0401OE14901187-126A
1.250	+ .002/- .000	0.952	+ .000/- .003	0.126	1.249	+ .000/- .002	119	0401OE14901250-126A
1.312	+ .002/- .000	1.014	+ .000/- .003	0.126	1.311	+ .000/- .002	120	0401OE14901312-126A
1.375	+ .002/- .000	1.077	+ .000/- .003	0.126	1.374	+ .000/- .002	121	0401OE14901375-126A
1.437	+ .002/- .000	1.139	+ .000/- .003	0.126	1.436	+ .000/- .002	122	0401OE14901437-126A
1.500	+ .002/- .000	1.202	+ .000/- .003	0.126	1.499	+ .000/- .002	123	0401OE14901500-126A
1.562	+ .002/- .000	1.176	+ .000/- .003	0.120	1.561	+ .000/- .002	123	0401OE19301562-120A
1.625	+ .002/- .000	1.239	+ .000/- .003	0.120	1.624	+ .000/- .002	124	0401OE19301625-120A
1.687	+ .002/- .000	1.301	+ .000/- .003	0.120	1.686	+ .000/- .002	125	0401OE19301687-120A
1.750	+ .002/- .000	1.364	+ .000/- .003	0.120	1.749	+ .000/- .002	126	0401OE19301750-120A
1.875	+ .002/- .000	1.489	+ .000/- .003	0.120	1.874	+ .000/- .002	128	0401OE19301875-120A
2.000	+ .002/- .000	1.614	+ .000/- .003	0.127	1.999	+ .000/- .002	130	0401OE19302000-127A
2.125	+ .002/- .000	1.739	+ .000/- .003	0.127	2.124	+ .000/- .002	132	0401OE19302125-127A
2.250	+ .002/- .000	1.864	+ .000/- .003	0.127	2.249	+ .000/- .002	134	0401OE19302250-127A
2.375	+ .002/- .000	1.989	+ .000/- .003	0.127	2.374	+ .000/- .002	136	0401OE19302375-127A
2.500	+ .002/- .000	2.114	+ .000/- .003	0.127	2.499	+ .000/- .002	138	0401OE19302500-127A
2.625	+ .002/- .000	2.239	+ .000/- .003	0.127	2.624	+ .000/- .002	140	0401OE19302625-127A
2.750	+ .002/- .000	2.364	+ .000/- .003	0.127	2.749	+ .000/- .002	142	0401OE19302750-127A
2.875	+ .003/- .000	2.451	+ .000/- .004	0.166	2.874	+ .000/- .003	230	0401OE21202875-166A
3.000	+ .003/- .000	2.576	+ .000/- .004	0.166	2.999	+ .000/- .003	231	0401OE21203000-166A
3.125	+ .003/- .000	2.701	+ .000/- .004	0.166	3.124	+ .000/- .003	232	0401OE21203125-166A
3.250	+ .003/- .000	2.826	+ .000/- .004	0.166	3.249	+ .000/- .003	233	0401OE21203250-166A
3.375	+ .003/- .000	2.951	+ .000/- .004	0.166	3.374	+ .000/- .003	234	0401OE21203375-166A
3.500	+ .003/- .000	3.076	+ .000/- .004	0.166	3.499	+ .000/- .003	235	0401OE21203500-166A
3.625	+ .003/- .000	3.201	+ .000/- .004	0.166	3.624	+ .000/- .003	236	0401OE21203625-166A
3.750	+ .003/- .000	3.326	+ .000/- .004	0.166	3.749	+ .000/- .003	237	0401OE21203750-166A
3.875	+ .003/- .000	3.451	+ .000/- .004	0.166	3.874	+ .000/- .003	238	0401OE21203875-166A
4.000	+ .003/- .000	3.576	+ .000/- .004	0.166	3.999	+ .000/- .003	239	0401OE21204000-166A
4.125	+ .003/- .000	3.701	+ .000/- .004	0.166	4.124	+ .000/- .003	240	0401OE21204125-166A
4.250	+ .003/- .000	3.826	+ .000/- .004	0.166	4.249	+ .000/- .003	241	0401OE21204250-166A
4.375	+ .003/- .000	3.951	+ .000/- .004	0.166	4.374	+ .000/- .003	242	0401OE21204375-166A
4.500	+ .003/- .000	4.076	+ .000/- .004	0.166	4.499	+ .000/- .003	243	0401OE21204500-166A

*If used with wear rings, refer to wear ring piston diameter.



OE Profile

GLAND DIMENSIONS – OE Profile – Inch (cont'd)

A Bore Diameter		B Groove Diameter		C Groove Width	D Piston Diameter*		O-ring Dash Number	Part Number
Dia.	Tol.	Dia.	Tol.	+ .005/ -.000	Dia.	Tol.		
4.625	+ .003/ -.000	4.009	+ .000/ -.006	0.247	4.623	+ .000/ -.003	345	0401OE30804625-247A
4.750	+ .003/ -.000	4.134	+ .000/ -.006	0.247	4.748	+ .000/ -.003	346	0401OE30804750-247A
4.875	+ .003/ -.000	4.259	+ .000/ -.006	0.247	4.873	+ .000/ -.003	347	0401OE30804875-247A
5.000	+ .003/ -.000	4.384	+ .000/ -.006	0.247	4.998	+ .000/ -.003	348	0401OE30805000-247A
5.125	+ .003/ -.000	4.509	+ .000/ -.006	0.247	5.123	+ .000/ -.003	349	0401OE30805125-247A
5.250	+ .003/ -.000	4.634	+ .000/ -.006	0.247	5.248	+ .000/ -.003	350	0401OE30805250-247A
5.375	+ .003/ -.000	4.759	+ .000/ -.006	0.247	5.373	+ .000/ -.003	351	0401OE30805375-247A
5.500	+ .003/ -.000	4.884	+ .000/ -.006	0.247	5.498	+ .000/ -.003	352	0401OE30805500-247A
5.625	+ .003/ -.000	5.009	+ .000/ -.006	0.247	5.623	+ .000/ -.003	353	0401OE30805625-247A
5.750	+ .003/ -.000	5.134	+ .000/ -.006	0.247	5.748	+ .000/ -.003	354	0401OE30805750-247A
5.875	+ .003/ -.000	5.259	+ .000/ -.006	0.247	5.873	+ .000/ -.003	355	0401OE30805875-247A
6.000	+ .003/ -.000	5.384	+ .000/ -.006	0.247	5.998	+ .000/ -.003	356	0401OE30806000-247A
6.125	+ .003/ -.000	5.509	+ .000/ -.006	0.247	6.123	+ .000/ -.003	357	0401OE30806125-247A
6.250	+ .003/ -.000	5.634	+ .000/ -.006	0.247	6.248	+ .000/ -.003	358	0401OE30806250-247A
6.375	+ .003/ -.000	5.759	+ .000/ -.006	0.247	6.373	+ .000/ -.003	359	0401OE30806375-247A
6.500	+ .003/ -.000	5.884	+ .000/ -.006	0.247	6.498	+ .000/ -.003	360	0401OE30806500-247A
6.750	+ .003/ -.000	6.134	+ .000/ -.006	0.247	6.748	+ .000/ -.003	361	0401OE30806750-247A
7.000	+ .003/ -.000	6.384	+ .000/ -.006	0.247	6.998	+ .000/ -.003	362	0401OE30807000-247A
7.250	+ .003/ -.000	6.634	+ .000/ -.006	0.247	7.248	+ .000/ -.003	363	0401OE30807250-247A
7.500	+ .003/ -.000	6.884	+ .000/ -.006	0.247	7.498	+ .000/ -.003	364	0401OE30807500-247A
7.750	+ .003/ -.000	7.134	+ .000/ -.006	0.247	7.748	+ .000/ -.003	365	0401OE30807750-247A
8.000	+ .003/ -.000	7.384	+ .000/ -.006	0.247	7.998	+ .000/ -.003	366	0401OE30808000-247A
8.250	+ .003/ -.000	7.634	+ .000/ -.006	0.247	8.248	+ .000/ -.003	367	0401OE30808250-247A
8.500	+ .003/ -.000	7.884	+ .000/ -.006	0.247	8.498	+ .000/ -.003	368	0401OE30808500-247A
9.000	+ .003/ -.000	8.384	+ .000/ -.006	0.247	8.998	+ .000/ -.003	370	0401OE30809000-247A
9.500	+ .003/ -.000	8.884	+ .000/ -.006	0.247	9.498	+ .000/ -.003	372	0401OE30809500-247A
10.000	+ .003/ -.000	9.384	+ .000/ -.006	0.247	9.998	+ .000/ -.003	374	0401OE30810000-247A



OE Profile

GLAND DIMENSIONS – OE Profile – Inch (cont'd)

A Bore Diameter		B Groove Diameter		C Groove Width	D Piston Diameter*		O-ring Dash Number	Part Number
Dia.	Tol.	Dia.	Tol.	+ .005/- .000	Dia.	Tol.		
7.000	+ .004/- .000	6.170	+ .000/- .007	0.320	6.998	+ .000/- .004	437	0401OE41507000-320A
7.250	+ .004/- .000	6.420	+ .000/- .007	0.320	7.248	+ .000/- .004	438	0401OE41507250-320A
7.500	+ .004/- .000	6.670	+ .000/- .007	0.320	7.498	+ .000/- .004	439	0401OE41507500-320A
7.750	+ .004/- .000	6.920	+ .000/- .007	0.320	7.748	+ .000/- .004	440	0401OE41507750-320A
8.000	+ .004/- .000	7.170	+ .000/- .007	0.320	7.998	+ .000/- .004	441	0401OE41508000-320A
8.250	+ .004/- .000	7.420	+ .000/- .007	0.320	8.248	+ .000/- .004	442	0401OE41508250-320A
8.500	+ .004/- .000	7.670	+ .000/- .007	0.320	8.498	+ .000/- .004	443	0401OE41508500-320A
9.000	+ .004/- .000	8.170	+ .000/- .007	0.320	8.998	+ .000/- .004	445	0401OE41509000-320A
9.500	+ .004/- .000	8.670	+ .000/- .007	0.320	9.498	+ .000/- .004	446	0401OE41509500-320A
10.000	+ .004/- .000	9.170	+ .000/- .007	0.320	9.998	+ .000/- .004	447	0401OE41510000-320A
10.500	+ .004/- .000	9.670	+ .000/- .007	0.320	10.498	+ .000/- .004	448	0401OE41510500-320A
11.000	+ .004/- .000	10.170	+ .000/- .007	0.320	10.998	+ .000/- .004	449	0401OE41511000-320A
11.500	+ .004/- .000	10.670	+ .000/- .007	0.320	11.498	+ .000/- .004	450	0401OE41511500-320A
12.000	+ .004/- .000	11.170	+ .000/- .007	0.320	11.998	+ .000/- .004	451	0401OE41512000-320A
12.500	+ .004/- .000	11.670	+ .000/- .007	0.320	12.498	+ .000/- .004	452	0401OE41512500-320A
13.000	+ .004/- .000	12.170	+ .000/- .007	0.320	12.998	+ .000/- .004	453	0401OE41513000-320A
13.500	+ .004/- .000	12.670	+ .000/- .007	0.320	13.498	+ .000/- .004	454	0401OE41513500-320A
14.000	+ .004/- .000	13.170	+ .000/- .007	0.320	13.998	+ .000/- .004	455	0401OE41514000-320A
14.500	+ .004/- .000	13.670	+ .000/- .007	0.320	14.498	+ .000/- .004	456	0401OE41514500-320A
15.000	+ .004/- .000	14.170	+ .000/- .007	0.320	14.998	+ .000/- .004	457	0401OE41515000-320A
15.500	+ .004/- .000	14.670	+ .000/- .007	0.320	15.498	+ .000/- .004	458	0401OE41515500-320A
16.000	+ .004/- .000	15.170	+ .000/- .007	0.320	15.998	+ .000/- .004	459	0401OE41516000-320A

*If used with wear rings, refer to wear ring piston diameter.

NOTE: For sizes larger than those shown in the table, please contact your local Parker Seal representative.



Rod or Piston Applications

Parker symmetric profiles are designed to fit the center of the gland. They are categorized as symmetric profiles because the shape of the outside diameter sealing lip matches the shape of the inside diameter sealing lip. This symmetrical design, with its centered fit in the gland, allows the profile to function either as a rod or piston seal.

ROD or PISTON PROFILES

Profile	Cross Section	Description	Standard Materials			Page
			0102	0502	0627	
Symmetric Seals Decision Tree						48
FBC FlexiSeal		PTFE jacket, cantilever spring energized lip seal for medium hydraulics	.	.	.	49

Symmetric Decision Tree

Symmetric seals may be used in either rod or piston applications.

ROD SEAL DECISION TREE

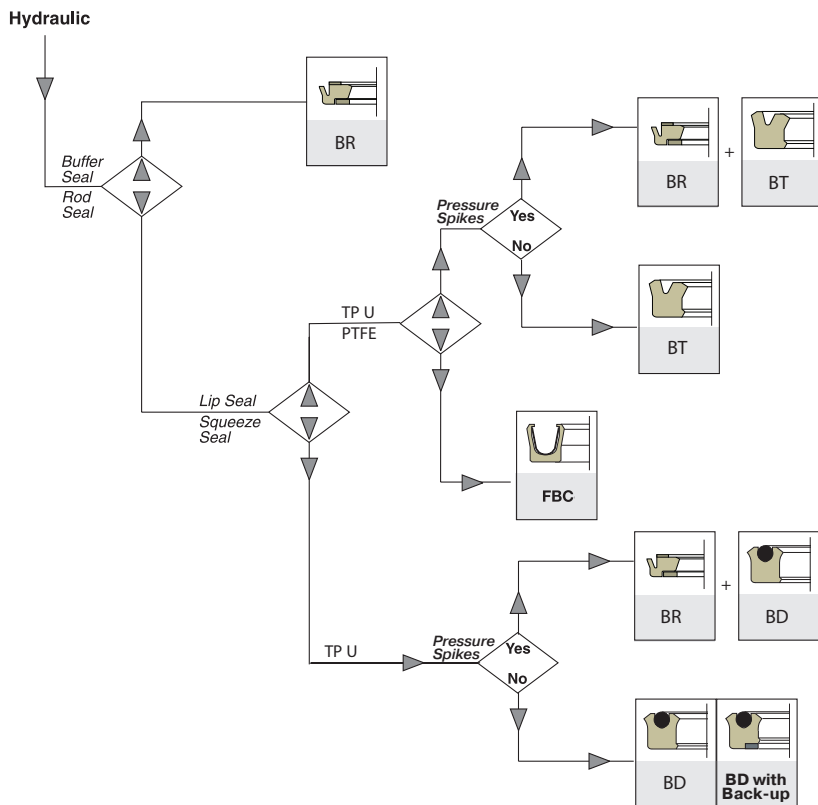

Piston Seal Decision Tree

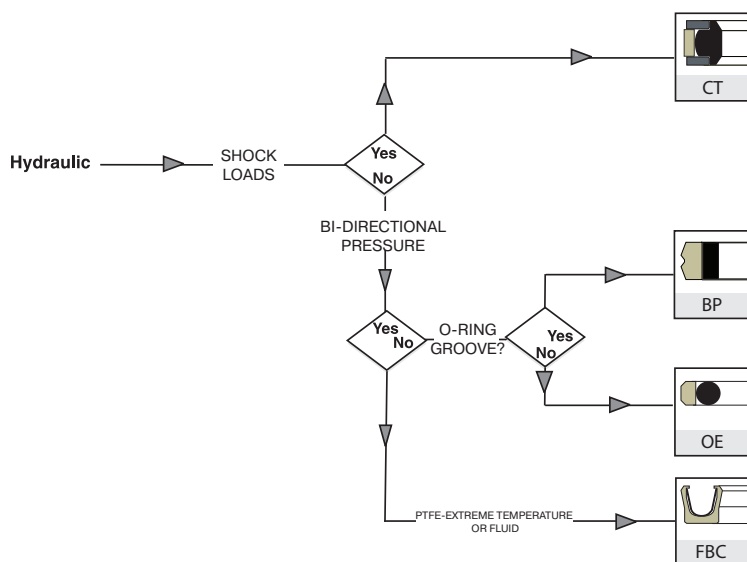

FlexiSeal® FBC Profile

Parker's FBC Profile FlexiSeal is a symmetrical spring-energized PTFE lip seal for rod and piston featuring beveled style lips, and cantilever spring for maximum ID and OD sealing. FlexiSeal profiles utilize a variety of PTFE jacket profiles, spring types and materials. PTFE and other machinable high performance materials of construction are used where elastomeric seals fail to meet an application's temperature range, chemical resistance or friction requirements and deliver advantages which include:

- Low friction
- Wide temperature range
- Ultra broad chemical compatibility
- Dry running ability in dynamic sealing applications
- Resistance to degradation, heat aging and physical property alteration during temperature cycling

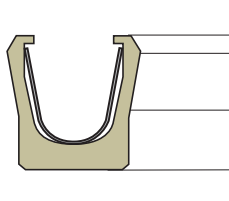
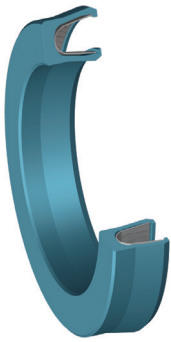

FBC Cross-Section

RANGE OF APPLICATION

Standard Material* Jacket	Temperature	Pressure	Speed
0102 Pigmented PTFE	-320°F to +450°F (-196°C to +233°C)	<1,000 psi (69 bar)	≤13 ft/s (4 m/s)
0502 Carbon fiber filled PTFE	-200°F to +550°F (-130°C to +290°C)	<3,000 psi (207 bar)	≤13 ft/s (4 m/s)
0627 PPS & Graphite filled PTFE	-250°F to +550°F (-121°C to +290°C)	<3,000 psi (207 bar)	≤13 ft/s (4 m/s)

Spring

Medium load, 301 stainless steel cantilever spring

**Alternate Materials: For applications that may require an alternate material, please contact your local Parker Seal representative.*

- Beveled lip concentrates lip sealing force for excellent film breaking
- Medium load V-spring energizes sealing lips
- Wide temperature range PTFE
- Ultra broad chemical compatibility

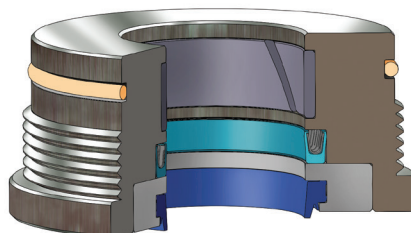

FBC installed in Rod Gland

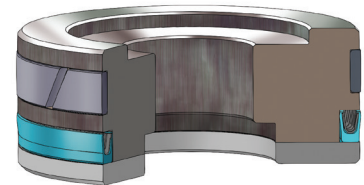

FBC installed in Piston Gland

FlexiSeal® FBC Profile

MATING SURFACE FINISH — Symmetrical FlexiSeal® FBC

Unlike elastomer contact seals, PTFE-based FlexiSeals can run on very smooth surfaces with or without lubrication. Due to the toughness and low coefficient of friction of PTFE, FlexiSeals slip over the high points of the mating surface and resist abrasion. To maximize seal performance, the recommendations for surface roughness in the adjacent table should be followed.

Dynamic surfaces with relatively rough finishes will result in higher wear rates which decrease the seal life and may compromise performance. For additional information on understanding and applying the benefits of appropriate hardware surface finish specifications please consult the Engineering Section of Parker's PTFE Lip Seal Design Guide (Catalog EPS 5340).

Surface Roughness, R_a for PTFE FlexiSeal FBC Profile

Media Being Sealed	Dynamic Surfaces		Static Surfaces	
	m Inch	m m	m Inch	m m
Cryogenics	6 max.	0.15 max.	8 max.	0.2 max.
Helium Gas Hydrogen Gas Freon	8 max.	0.2 max.	12 max.	0.3 max.
Air Nitrogen Gas Argon Natural Gas Fuel (Aircraft & Auto-motive)	12 max.	0.3 max.	16 max.	0.4 max.
Water Hydraulic Oil Crude Oil Sealants	12 max.	0.3 max.	32 max.	0.8 max.

SEAL HEIGHT CALLOUTS, GROOVE WIDTH AND MAX RADIUS — FBC Profile — Inch

Nominal Size / Gland Depth	A		B		C			
	Seal Range		Groove		Standard Heel		Extended Heel	
	Dia.	Tol.	Dia.	Tol.	Callout	Groove Width	Callout	Groove Width
062	0.125 - 2.500	+ .000 / - .001	Dia A + 0.125	+ .001 / - .000	083	0.094 / 0.104	140	0.149 / 0.159
093	0.187 - 4.000	+ .000 / - .002	Dia A + 0.187	+ .002 / - .000	130	0.141 / 0.151	173	0.183 / 0.193
125	0.375 - 6.000	+ .000 / - .002	Dia A + 0.250	+ .002 / - .000	170	0.188 / 0.198	220	0.235 / 0.245
187	0.875 - 8.000	+ .000 / - .002	Dia A + 0.375	+ .002 / - .000	260	0.281 / 0.291	310	0.334 / 0.344
250	1.625 - 12.000	+ .000 / - .003	Dia A + 0.500	+ .003 / - .000	355	0.375 / 0.385	450	0.475 / 0.485



FlexiSeal® FBC Profile

PART NUMBER NOMENCLATURE — Symmetrical FlexiSeal® FBC

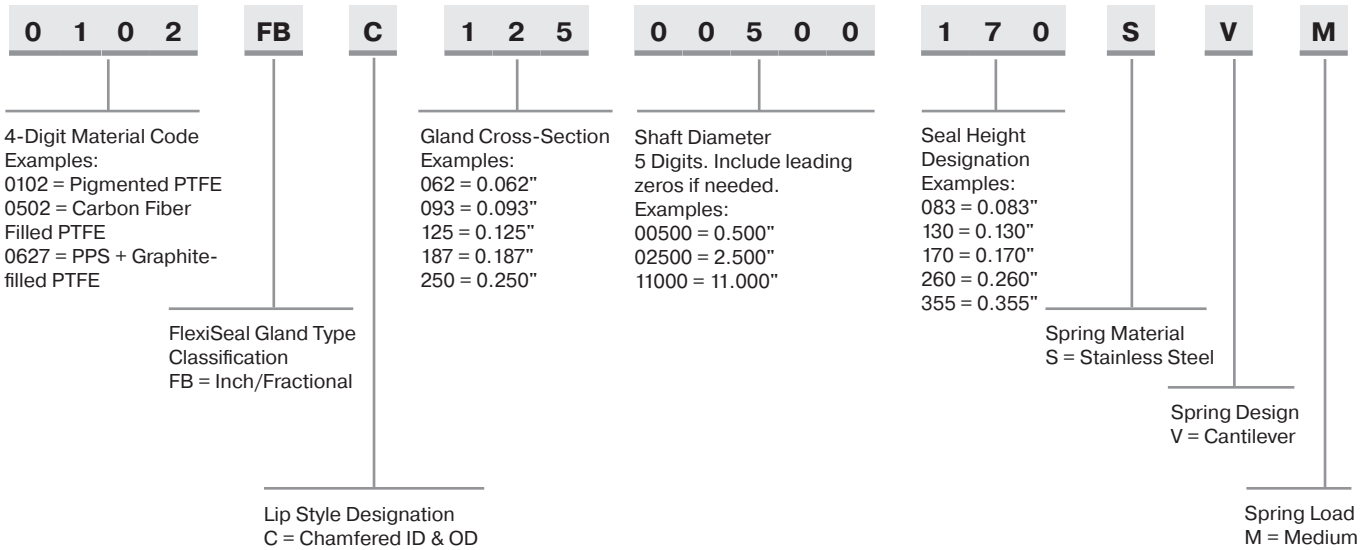

GLAND DIMENSIONS — FBC PROFILE

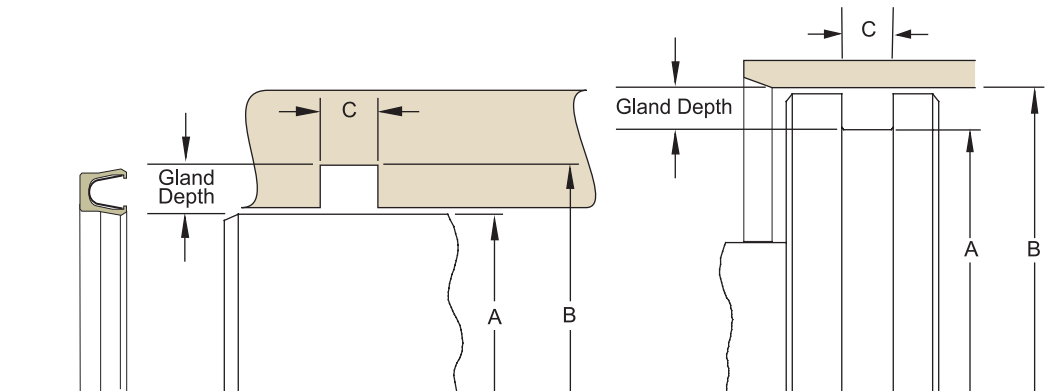

Please refer to the [Engineering Section](#) for surface finish and additional hardware considerations.

FlexiSeal® FBC Profile

GLAND DIMENSIONS – FlexiSeal FBC – Inch

Nominal Size / Gland Depth	A Rod or Groove Diameter		B Bore or Groove Diameter		Part Number xxxx = Material Code yyy = Heel Callout
	Dia.	Tol.	Dia.	Tol.	
062	0.125	+0.000/-0.001	0.250	+0.001/-0.000	xxxxFBC06200125yyySVM
	0.187	+0.000/-0.001	0.312	+0.001/-0.000	xxxxFBC06200187yyySVM
	0.250	+0.000/-0.001	0.375	+0.001/-0.000	xxxxFBC06200250yyySVM
	0.312	+0.000/-0.001	0.437	+0.001/-0.000	xxxxFBC06200312yyySVM
	0.375	+0.000/-0.001	0.500	+0.001/-0.000	xxxxFBC06200375yyySVM
	0.437	+0.000/-0.001	0.562	+0.001/-0.000	xxxxFBC06200437yyySVM
	0.500	+0.000/-0.001	0.625	+0.001/-0.000	xxxxFBC06200500yyySVM
	0.562	+0.000/-0.001	0.687	+0.001/-0.000	xxxxFBC06200562yyySVM
	0.625	+0.000/-0.001	0.750	+0.001/-0.000	xxxxFBC06200625yyySVM
	0.687	+0.000/-0.001	0.812	+0.001/-0.000	xxxxFBC06200687yyySVM
	0.750	+0.000/-0.001	0.875	+0.001/-0.000	xxxxFBC06200750yyySVM
	0.812	+0.000/-0.001	0.937	+0.001/-0.000	xxxxFBC06200812yyySVM
	0.875	+0.000/-0.001	1.000	+0.001/-0.000	xxxxFBC06200875yyySVM
	0.937	+0.000/-0.001	1.062	+0.001/-0.000	xxxxFBC06200937yyySVM
	1.000	+0.000/-0.001	1.125	+0.001/-0.000	xxxxFBC06201000yyySVM
	1.062	+0.000/-0.001	1.187	+0.001/-0.000	xxxxFBC06201062yyySVM
	1.125	+0.000/-0.001	1.250	+0.001/-0.000	xxxxFBC06201125yyySVM
	1.187	+0.000/-0.001	1.312	+0.001/-0.000	xxxxFBC06201187yyySVM
	1.250	+0.000/-0.001	1.375	+0.001/-0.000	xxxxFBC06201250yyySVM
	1.312	+0.000/-0.001	1.437	+0.001/-0.000	xxxxFBC06201312yyySVM
	1.375	+0.000/-0.001	1.500	+0.001/-0.000	xxxxFBC06201375yyySVM
	1.500	+0.000/-0.001	1.625	+0.001/-0.000	xxxxFBC06201500yyySVM
	1.625	+0.000/-0.001	1.750	+0.001/-0.000	xxxxFBC06201625yyySVM
	1.750	+0.000/-0.001	1.875	+0.001/-0.000	xxxxFBC06201750yyySVM
1.875	+0.000/-0.001	2.000	+0.001/-0.000	xxxxFBC06201875yyySVM	
2.000	+0.000/-0.001	2.125	+0.001/-0.000	xxxxFBC06202000yyySVM	
2.125	+0.000/-0.001	2.250	+0.001/-0.000	xxxxFBC06202125yyySVM	
2.250	+0.000/-0.001	2.375	+0.001/-0.000	xxxxFBC06202250yyySVM	
2.375	+0.000/-0.001	2.500	+0.001/-0.000	xxxxFBC06202375yyySVM	
2.500	+0.000/-0.001	2.625	+0.001/-0.000	xxxxFBC06202500yyySVM	



FlexiSeal® FBC Profile

GLAND DIMENSIONS – FlexiSeal FBC – Inch (cont'd)

Nominal Size / Gland Depth	A Rod or Groove Diameter		B Bore or Groove Diameter		Part Number xxxx = Material Code yyy = Heel Callout
	Dia.	Tol.	Dia.	Tol.	
093	0.187	+0.000/-0.002	0.375	+0.002/-0.000	xxxxFBC09300187yyySVM
	0.250	+0.000/-0.002	0.437	+0.002/-0.000	xxxxFBC09300250yyySVM
	0.312	+0.000/-0.002	0.500	+0.002/-0.000	xxxxFBC09300312yyySVM
	0.375	+0.000/-0.002	0.562	+0.002/-0.000	xxxxFBC09300375yyySVM
	0.437	+0.000/-0.002	0.625	+0.002/-0.000	xxxxFBC09300437yyySVM
	0.500	+0.000/-0.002	0.687	+0.002/-0.000	xxxxFBC09300500yyySVM
	0.562	+0.000/-0.002	0.750	+0.002/-0.000	xxxxFBC09300562yyySVM
	0.625	+0.000/-0.002	0.812	+0.002/-0.000	xxxxFBC09300625yyySVM
	0.687	+0.000/-0.002	0.875	+0.002/-0.000	xxxxFBC09300687yyySVM
	0.750	+0.000/-0.002	0.937	+0.002/-0.000	xxxxFBC09300750yyySVM
	0.812	+0.000/-0.002	1.000	+0.002/-0.000	xxxxFBC09300812yyySVM
	0.875	+0.000/-0.002	1.062	+0.002/-0.000	xxxxFBC09300875yyySVM
	0.937	+0.000/-0.002	1.125	+0.002/-0.000	xxxxFBC09300937yyySVM
	1.000	+0.000/-0.002	1.187	+0.002/-0.000	xxxxFBC09301000yyySVM
	1.062	+0.000/-0.002	1.250	+0.002/-0.000	xxxxFBC09301062yyySVM
	1.250	+0.000/-0.002	1.437	+0.002/-0.000	xxxxFBC09301250yyySVM
	1.312	+0.000/-0.002	1.500	+0.002/-0.000	xxxxFBC09301312yyySVM
	1.500	+0.000/-0.002	1.687	+0.002/-0.000	xxxxFBC09301500yyySVM
	1.562	+0.000/-0.002	1.750	+0.002/-0.000	xxxxFBC09301562yyySVM
	1.750	+0.000/-0.002	1.937	+0.002/-0.000	xxxxFBC09301750yyySVM
	1.812	+0.000/-0.002	2.000	+0.002/-0.000	xxxxFBC09301812yyySVM
	2.000	+0.000/-0.002	2.187	+0.002/-0.000	xxxxFBC09302000yyySVM
	2.312	+0.000/-0.002	2.500	+0.002/-0.000	xxxxFBC09302312yyySVM
	2.500	+0.000/-0.002	2.687	+0.002/-0.000	xxxxFBC09302500yyySVM
	2.812	+0.000/-0.002	3.000	+0.002/-0.000	xxxxFBC09302812yyySVM
	3.000	+0.000/-0.002	3.187	+0.002/-0.000	xxxxFBC09303000yyySVM
	3.312	+0.000/-0.002	3.500	+0.002/-0.000	xxxxFBC09303312yyySVM
	3.500	+0.000/-0.002	3.687	+0.002/-0.000	xxxxFBC09303500yyySVM
	3.812	+0.000/-0.002	4.000	+0.002/-0.000	xxxxFBC09303812yyySVM
	4.000	+0.000/-0.002	4.187	+0.002/-0.000	xxxxFBC09304000yyySVM



FlexiSeal® FBC Profile

GLAND DIMENSIONS – FlexiSeal FBC – Inch (cont'd)

Nominal Size / Gland Depth	A Rod or Groove Diameter		B Bore or Groove Diameter		Part Number xxxx = Material Code yyy = Heel Callout
	Dia.	Tol.	Dia.	Tol.	
125	0.375	+0.000/-0.002	0.625	+0.002/-0.000	xxxxFBC12500375yyySVM
	0.500	+0.000/-0.002	0.750	+0.002/-0.000	xxxxFBC12500500yyySVM
	0.625	+0.000/-0.002	0.875	+0.002/-0.000	xxxxFBC12500625yyySVM
	0.750	+0.000/-0.002	1.000	+0.002/-0.000	xxxxFBC12500750yyySVM
	0.875	+0.000/-0.002	1.125	+0.002/-0.000	xxxxFBC12500875yyySVM
	1.000	+0.000/-0.002	1.250	+0.002/-0.000	xxxxFBC12501000yyySVM
	1.125	+0.000/-0.002	1.375	+0.002/-0.000	xxxxFBC12501125yyySVM
	1.250	+0.000/-0.002	1.500	+0.002/-0.000	xxxxFBC12501250yyySVM
	1.375	+0.000/-0.002	1.625	+0.002/-0.000	xxxxFBC12501375yyySVM
	1.500	+0.000/-0.002	1.750	+0.002/-0.000	xxxxFBC12501500yyySVM
	1.625	+0.000/-0.002	1.875	+0.002/-0.000	xxxxFBC12501625yyySVM
	1.750	+0.000/-0.002	2.000	+0.002/-0.000	xxxxFBC12501750yyySVM
	1.875	+0.000/-0.002	2.125	+0.002/-0.000	xxxxFBC12501875yyySVM
	2.000	+0.000/-0.002	2.250	+0.002/-0.000	xxxxFBC12502000yyySVM
	2.250	+0.000/-0.002	2.500	+0.002/-0.000	xxxxFBC12502250yyySVM
	2.500	+0.000/-0.002	2.750	+0.002/-0.000	xxxxFBC12502500yyySVM
	2.750	+0.000/-0.002	3.000	+0.002/-0.000	xxxxFBC12502750yyySVM
	3.000	+0.000/-0.002	3.250	+0.002/-0.000	xxxxFBC12503000yyySVM
	3.250	+0.000/-0.002	3.500	+0.002/-0.000	xxxxFBC12503250yyySVM
	3.500	+0.000/-0.002	3.750	+0.002/-0.000	xxxxFBC12503500yyySVM
	3.750	+0.000/-0.002	4.000	+0.002/-0.000	xxxxFBC12503750yyySVM
	4.000	+0.000/-0.002	4.250	+0.002/-0.000	xxxxFBC12504000yyySVM
	4.250	+0.000/-0.002	4.500	+0.002/-0.000	xxxxFBC12504250yyySVM
	4.500	+0.000/-0.002	4.750	+0.002/-0.000	xxxxFBC12504500yyySVM
4.750	+0.000/-0.002	5.000	+0.002/-0.000	xxxxFBC12504750yyySVM	
5.000	+0.000/-0.002	5.250	+0.002/-0.000	xxxxFBC12505000yyySVM	
5.250	+0.000/-0.002	5.500	+0.002/-0.000	xxxxFBC12505250yyySVM	
5.500	+0.000/-0.002	5.750	+0.002/-0.000	xxxxFBC12505500yyySVM	
5.750	+0.000/-0.002	6.000	+0.002/-0.000	xxxxFBC12505750yyySVM	
6.000	+0.000/-0.002	6.250	+0.002/-0.000	xxxxFBC12506000yyySVM	



FlexiSeal® FBC Profile

GLAND DIMENSIONS — FlexiSeal FBC — Inch (cont'd)

Nominal Size / Gland Depth	A Rod or Groove Diameter		B Bore or Groove Diameter		Part Number xxxx = Material Code yyy = Heel Callout
	Dia.	Tol.	Dia.	Tol.	
187	0.875	+0.000/-0.002	1.250	+0.002/-0.000	xxxxFBC18700875yyySVM
	1.000	+0.000/-0.002	1.375	+0.002/-0.000	xxxxFBC18701000yyySVM
	1.125	+0.000/-0.002	1.500	+0.002/-0.000	xxxxFBC18701125yyySVM
	1.500	+0.000/-0.002	1.875	+0.002/-0.000	xxxxFBC18701500yyySVM
	1.625	+0.000/-0.002	2.000	+0.002/-0.000	xxxxFBC18701625yyySVM
	2.000	+0.000/-0.002	2.375	+0.002/-0.000	xxxxFBC18702000yyySVM
	2.125	+0.000/-0.002	2.500	+0.002/-0.000	xxxxFBC18702125yyySVM
	2.500	+0.000/-0.002	2.875	+0.002/-0.000	xxxxFBC18702500yyySVM
	2.625	+0.000/-0.002	3.000	+0.002/-0.000	xxxxFBC18702625yyySVM
	3.000	+0.000/-0.002	3.375	+0.002/-0.000	xxxxFBC18703000yyySVM
	3.125	+0.000/-0.002	3.500	+0.002/-0.000	xxxxFBC18703125yyySVM
	3.500	+0.000/-0.002	3.875	+0.002/-0.000	xxxxFBC18703500yyySVM
	3.625	+0.000/-0.002	4.000	+0.002/-0.000	xxxxFBC18703625yyySVM
	4.000	+0.000/-0.002	4.375	+0.002/-0.000	xxxxFBC18704000yyySVM
	4.125	+0.000/-0.002	4.500	+0.002/-0.000	xxxxFBC18704125yyySVM
	4.500	+0.000/-0.002	4.875	+0.002/-0.000	xxxxFBC18704500yyySVM
	4.625	+0.000/-0.002	5.000	+0.002/-0.000	xxxxFBC18704625yyySVM
	5.000	+0.000/-0.002	5.375	+0.002/-0.000	xxxxFBC18705000yyySVM
	5.125	+0.000/-0.002	5.500	+0.002/-0.000	xxxxFBC18705125yyySVM
	5.500	+0.000/-0.002	5.875	+0.002/-0.000	xxxxFBC18705500yyySVM
	5.625	+0.000/-0.002	6.000	+0.002/-0.000	xxxxFBC18705625yyySVM
	6.000	+0.000/-0.002	6.375	+0.002/-0.000	xxxxFBC18706000yyySVM
	6.125	+0.000/-0.002	6.500	+0.002/-0.000	xxxxFBC18706125yyySVM
	6.500	+0.000/-0.002	6.875	+0.002/-0.000	xxxxFBC18706500yyySVM
	6.625	+0.000/-0.002	7.000	+0.002/-0.000	xxxxFBC18706625yyySVM
	7.000	+0.000/-0.002	7.375	+0.002/-0.000	xxxxFBC18707000yyySVM
	7.125	+0.000/-0.002	7.500	+0.002/-0.000	xxxxFBC18707125yyySVM
	7.500	+0.000/-0.002	7.875	+0.002/-0.000	xxxxFBC18707500yyySVM
	7.625	+0.000/-0.002	8.000	+0.002/-0.000	xxxxFBC18707625yyySVM
	8.000	+0.000/-0.002	8.375	+0.002/-0.000	xxxxFBC18708000yyySVM



FlexiSeal® FBC Profile



GLAND DIMENSIONS – FlexiSeal FBC – Inch

Nominal Size / Gland Depth	A Rod or Groove Diameter		B Bore or Groove Diameter		Part Number xxxx = Material Code yyy = Heel Callout
	Dia.	Tol.	Dia.	Tol.	
250	1.625	+0.000/-0.003	2.125	+0.003/-0.000	xxxxFBC25001625yyySVM
	2.000	+0.000/-0.003	2.500	+0.003/-0.000	xxxxFBC25002000yyySVM
	2.250	+0.000/-0.003	2.750	+0.003/-0.000	xxxxFBC25002250yyySVM
	2.500	+0.000/-0.003	3.000	+0.003/-0.000	xxxxFBC25002500yyySVM
	2.750	+0.000/-0.003	3.250	+0.003/-0.000	xxxxFBC25002750yyySVM
	3.000	+0.000/-0.003	3.500	+0.003/-0.000	xxxxFBC25003000yyySVM
	3.250	+0.000/-0.003	3.750	+0.003/-0.000	xxxxFBC25003250yyySVM
	3.500	+0.000/-0.003	4.000	+0.003/-0.000	xxxxFBC25003500yyySVM
	3.750	+0.000/-0.003	4.250	+0.003/-0.000	xxxxFBC25003750yyySVM
	4.000	+0.000/-0.003	4.500	+0.003/-0.000	xxxxFBC25004000yyySVM
	4.250	+0.000/-0.003	4.750	+0.003/-0.000	xxxxFBC25004250yyySVM
	4.500	+0.000/-0.003	5.000	+0.003/-0.000	xxxxFBC25004500yyySVM
	4.750	+0.000/-0.003	5.250	+0.003/-0.000	xxxxFBC25004750yyySVM
	5.000	+0.000/-0.003	5.500	+0.003/-0.000	xxxxFBC25005000yyySVM
	5.250	+0.000/-0.003	5.750	+0.003/-0.000	xxxxFBC25005250yyySVM
	5.500	+0.000/-0.003	6.000	+0.003/-0.000	xxxxFBC25005500yyySVM
	5.750	+0.000/-0.003	6.250	+0.003/-0.000	xxxxFBC25005750yyySVM
	6.000	+0.000/-0.003	6.500	+0.003/-0.000	xxxxFBC25006000yyySVM
	6.500	+0.000/-0.003	7.000	+0.003/-0.000	xxxxFBC25006500yyySVM
	7.000	+0.000/-0.003	7.500	+0.003/-0.000	xxxxFBC25007000yyySVM
	7.500	+0.000/-0.003	8.000	+0.003/-0.000	xxxxFBC25007500yyySVM
	8.000	+0.000/-0.003	8.500	+0.003/-0.000	xxxxFBC25008000yyySVM
	8.500	+0.000/-0.003	9.000	+0.003/-0.000	xxxxFBC25008500yyySVM
	9.000	+0.000/-0.003	9.500	+0.003/-0.000	xxxxFBC25009000yyySVM
9.500	+0.000/-0.003	10.000	+0.003/-0.000	xxxxFBC25009500yyySVM	
10.000	+0.000/-0.003	10.500	+0.003/-0.000	xxxxFBC25010000yyySVM	
10.500	+0.000/-0.003	11.000	+0.003/-0.000	xxxxFBC25010500yyySVM	
11.000	+0.000/-0.003	11.500	+0.003/-0.000	xxxxFBC25011000yyySVM	
11.500	+0.000/-0.003	12.000	+0.003/-0.000	xxxxFBC25011500yyySVM	
12.000	+0.000/-0.003	12.500	+0.003/-0.000	xxxxFBC25012000yyySVM	

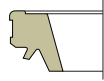

Parker rod wiper profiles represent the latest in advanced sealing technology for today's fluid power equipment. The combination of optimized geometry and high performance material results in highly engineered designs that offer the best possible solution for long life and improved performance.

ROD WIPER PROFILES

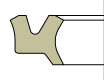
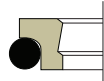
Profile	Cross Section	Description	Standard Material			Page
			4300	4700	0401	
Rod Wiper Decision Tree						58
YD		Premium snap-in wiper with O.D. exclusion technology	•			59
J		Performance canned wiper for medium- to heavy-duty service		•		62
AY		Premium double-lip wiper for light-, medium- and heavy-duty hydraulic service	•			65
AD		PTFE wiper for light- to medium-duty hydraulic service			•	69

Wiper Decision Tree

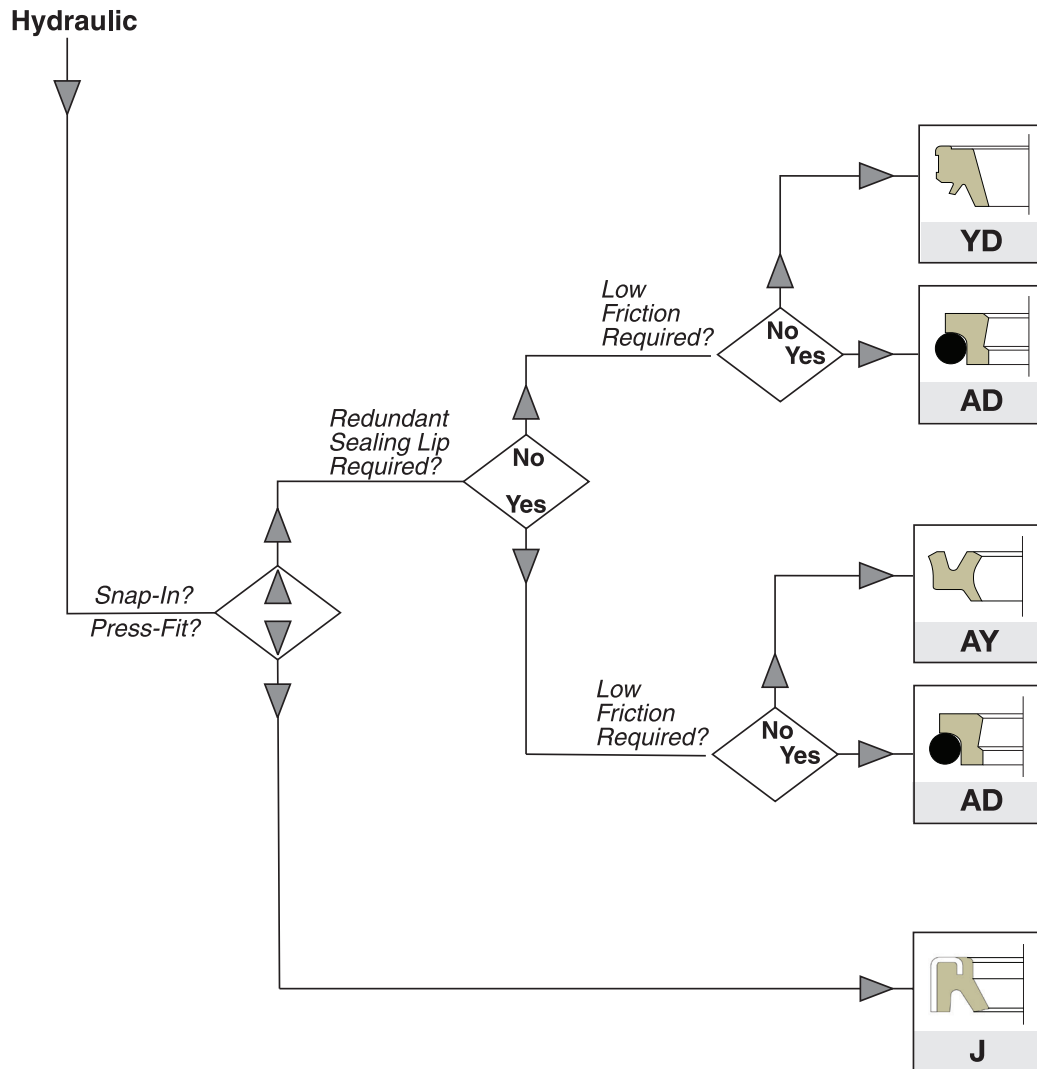

NOTE: Decision Tree is for profile geometry only. Please refer to profile for proper material selection.

YD Profile

The YD profile wiper is the premier design among high performance, snap-in excluders. Featuring a secondary O.D. lip which seals against the shoulder region of the gland, the YD profile wiper prevents water and other contaminants from entering around the static side of the wiper. For ultimate performance, the YD profile also incorporates an aggressive, knife-trimmed wiping lip to ensure maximum exclusion along the rod. A true zero-radius lip provides the most effective wiping action available.



RANGE OF APPLICATION

Standard Material*	Temperature	Speed
P4300A90	-65°F to +275°F (-54°C to +135°C)	< 1.6 ft/s (0.5 m/s)
Additional Material		
P4301A90	-35°F to +225°F (-37°C to +107°C)	< 1.6 ft/s (0.5 m/s)

**Alternate Materials: For applications that may require an alternate material, please contact your local Parker seal representative.*

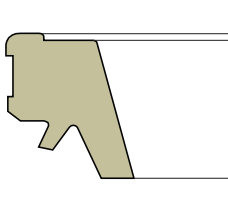

YD Cross-Section

- Premium Resilon® polyurethane material
- Secondary O.D. lip seals out contaminants
- Aggressive, knife-trimmed wiping lip
- Snap-in installation

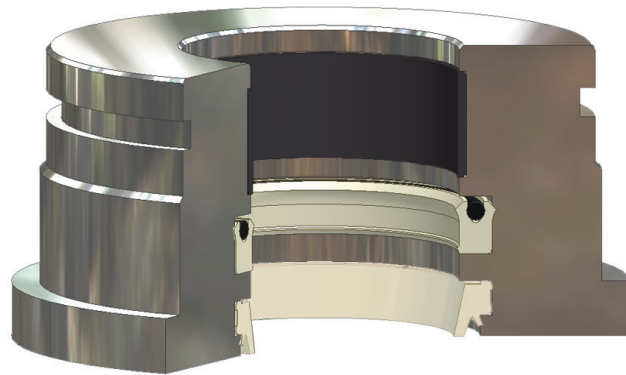

YD installed in Rod Gland

YD Profile

PART NUMBER NOMENCLATURE

YD Profile – Inch

4 3 0 0	YD	0 1 5 0 0
Seal Compound 4-Digit Material Code Example: 4300 = 90A Resilon® Polyurethane	Profile	Nominal Rod Diameter (x1000) 5 Digits. Include leading zeros if needed. Example: 1.500" x 1000 = 01500

GLAND DIMENSIONS – YD Profile

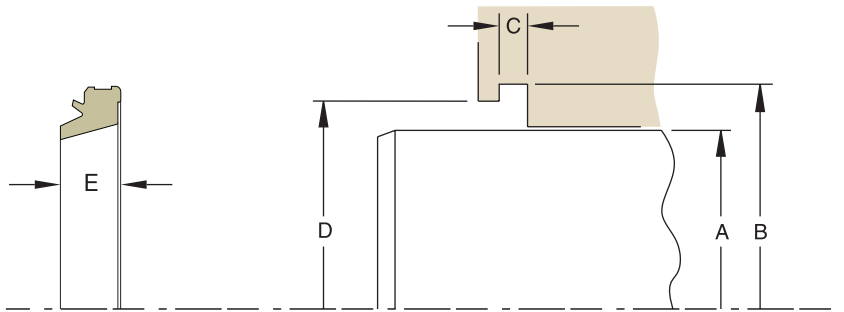

Please refer to the [Engineering Section](#) for surface finish and additional hardware considerations.

GLAND DIMENSIONS – YD Profile – Inch

Hardware Dimensions							E Max Wiper Axial Width	Part Number
A Rod Diameter		B Groove Diameter		C Groove Width	D Shoulder Diameter			
Dia.	Tol.	Dia.	Tol.	+0.004/-0.000	Dia.	Tol.		
0.250	+0.000/-0.001	0.497	+0.006/-0.000	0.124	0.410	+0.005/-0.000	0.215	4300YD00250
0.312	+0.000/-0.001	0.560	+0.006/-0.000	0.124	0.475	+0.005/-0.000	0.215	4300YD00312
0.375	+0.000/-0.001	0.622	+0.006/-0.000	0.124	0.535	+0.005/-0.000	0.215	4300YD00375
0.437	+0.000/-0.001	0.685	+0.006/-0.000	0.124	0.600	+0.005/-0.000	0.215	4300YD00437
0.500	+0.000/-0.001	0.747	+0.006/-0.000	0.124	0.660	+0.005/-0.000	0.215	4300YD00500
0.625	+0.000/-0.001	0.872	+0.006/-0.000	0.124	0.785	+0.005/-0.000	0.215	4300YD00625
0.750	+0.000/-0.001	1.122	+0.006/-0.000	0.187	0.995	+0.005/-0.000	0.315	4300YD00750

Above table reflects recommended cross-sections for rod diameters shown. For alternate cross-sections and additional sizes, contact your Parker representative for assistance.



YD Profile

GLAND DIMENSIONS – YD Profile – Inch (cont'd)

Hardware Dimensions							E Max Wiper Axial Width	Part Number
A Rod Diameter		B Groove Diameter		C Groove Width	D Shoulder Diameter			
Dia.	Tol.	Dia.	Tol.	+ .004/- .000	Dia.	Tol.		
0.875	+ .000/- .001	1.247	+ .006/- .000	0.187	1.120	+ .005/- .000	0.315	4300YD00875
1.000	+ .000/- .002	1.372	+ .006/- .000	0.187	1.245	+ .005/- .000	0.315	4300YD01000
1.125	+ .000/- .002	1.497	+ .006/- .000	0.187	1.370	+ .005/- .000	0.315	4300YD01125
1.250	+ .000/- .002	1.622	+ .006/- .000	0.187	1.495	+ .005/- .000	0.315	4300YD01250
1.375	+ .000/- .002	1.747	+ .006/- .000	0.187	1.620	+ .005/- .000	0.315	4300YD01375
1.500	+ .000/- .002	1.872	+ .006/- .000	0.187	1.745	+ .005/- .000	0.315	4300YD01500
1.625	+ .000/- .002	1.997	+ .006/- .000	0.187	1.870	+ .005/- .000	0.315	4300YD01625
1.750	+ .000/- .002	2.122	+ .006/- .000	0.187	1.995	+ .005/- .000	0.315	4300YD01750
1.875	+ .000/- .002	2.247	+ .006/- .000	0.187	2.120	+ .005/- .000	0.315	4300YD01875
2.000	+ .000/- .002	2.497	+ .006/- .000	0.249	2.327	+ .005/- .000	0.415	4300YD02000
2.125	+ .000/- .002	2.622	+ .006/- .000	0.249	2.452	+ .005/- .000	0.415	4300YD02125
2.250	+ .000/- .002	2.747	+ .006/- .000	0.249	2.577	+ .005/- .000	0.415	4300YD02250
2.375	+ .000/- .002	2.872	+ .006/- .000	0.249	2.702	+ .005/- .000	0.415	4300YD02375
2.500	+ .000/- .002	2.997	+ .006/- .000	0.249	2.827	+ .005/- .000	0.415	4300YD02500
2.625	+ .000/- .002	3.122	+ .006/- .000	0.249	2.952	+ .005/- .000	0.415	4300YD02625
2.750	+ .000/- .002	3.247	+ .006/- .000	0.249	3.077	+ .005/- .000	0.415	4300YD02750
3.000	+ .000/- .002	3.497	+ .006/- .000	0.249	3.327	+ .005/- .000	0.415	4300YD03000
3.250	+ .000/- .002	3.747	+ .006/- .000	0.249	3.577	+ .005/- .000	0.415	4300YD03250
3.500	+ .000/- .002	3.997	+ .006/- .000	0.249	3.827	+ .005/- .000	0.415	4300YD03500
3.750	+ .000/- .002	4.247	+ .006/- .000	0.249	4.077	+ .005/- .000	0.415	4300YD03750
4.000	+ .000/- .002	4.497	+ .006/- .000	0.249	4.327	+ .005/- .000	0.415	4300YD04000
4.250	+ .000/- .002	4.747	+ .006/- .000	0.249	4.577	+ .005/- .000	0.415	4300YD04250
4.500	+ .000/- .002	5.247	+ .006/- .000	0.374	4.993	+ .005/- .000	0.620	4300YD04500
4.750	+ .000/- .002	5.497	+ .006/- .000	0.374	5.243	+ .005/- .000	0.620	4300YD04750
5.000	+ .000/- .002	5.747	+ .006/- .000	0.374	5.493	+ .005/- .000	0.620	4300YD05000
5.500	+ .000/- .002	6.247	+ .006/- .000	0.374	5.993	+ .005/- .000	0.620	4300YD05500
6.000	+ .000/- .002	6.747	+ .006/- .000	0.374	6.493	+ .005/- .000	0.620	4300YD06000
6.500	+ .000/- .002	7.247	+ .006/- .000	0.374	6.993	+ .005/- .000	0.620	4300YD06500
6.750	+ .000/- .002	7.497	+ .006/- .000	0.374	7.243	+ .005/- .000	0.620	4300YD06750
7.000	+ .000/- .002	7.747	+ .006/- .000	0.374	7.493	+ .005/- .000	0.620	4300YD07000
7.500	+ .000/- .002	8.247	+ .006/- .000	0.374	7.993	+ .005/- .000	0.620	4300YD07500
8.000	+ .000/- .003	8.747	+ .006/- .000	0.374	8.493	+ .005/- .000	0.620	4300YD08000
8.500	+ .000/- .003	9.247	+ .006/- .000	0.374	8.993	+ .005/- .000	0.620	4300YD08500
9.000	+ .000/- .003	9.747	+ .006/- .000	0.374	9.493	+ .005/- .000	0.620	4300YD09000
10.000	+ .000/- .003	10.997	+ .006/- .000	0.374	10.659	+ .005/- .000	0.820	4300YD10000

Above table reflects recommended cross-sections for rod diameters shown. For alternate cross-sections and additional sizes, contact your Parker representative for assistance.



J Profile

The press-fit installation of Parker's J profile wiper guards against O.D. contamination. The wiping lip on the J profile wiper is very aggressive, eliminating the ingress of dust, mud and moisture from harsh work areas. J profile wipers are ideal for medium and heavy duty hydraulic cylinders in the most demanding applications.



RANGE OF APPLICATION

Standard Material	Temperature	Speed
P4700A90	-65°F to +200°F	< 1.6 ft/s
Carbon Steel	(-54°C to +93°C)	(0.5 m/s)

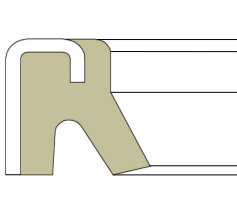

J Cross-Section

- Press-fit installation allows for simplified hardware machining
- Aggressive, knife-trimmed wiping lip excludes contaminants
- Ideal for medium- to heavy-duty-service

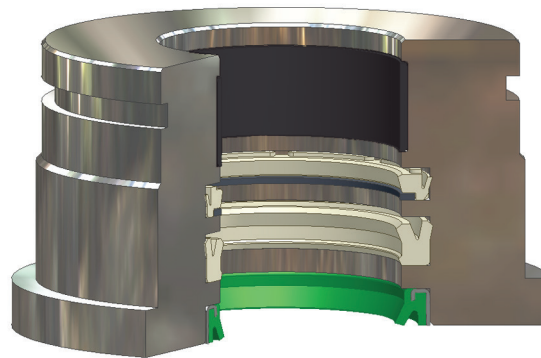

J installed in Rod Gland

J Profile

PART NUMBER NOMENCLATURE

J Profile – Inch

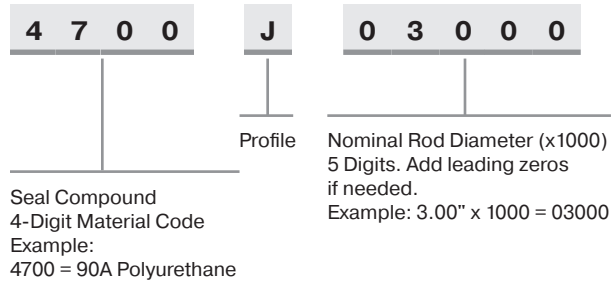

GLAND DIMENSIONS – J Profile

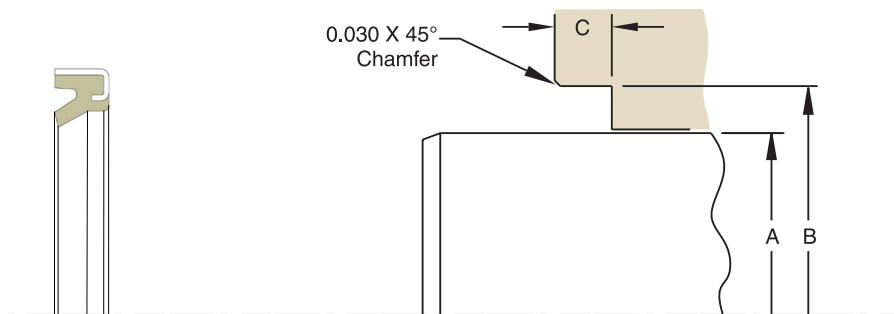

Please refer to the [Engineering Section](#) for surface finish and additional hardware considerations.

J Profile

GLAND DIMENSIONS — J Profile — Inch

Hardware Dimensions					Part Number
A Rod Diameter		B Groove Diameter		C Groove Width	
Dia.	Tol.	Dia.	Tol.	+ .015 / - .000	
0.750	+ .000 / - .002	1.250	+ .001 / - .001	0.312	4700J00750
0.875	+ .000 / - .002	1.375	+ .001 / - .001	0.312	4700J00875
1.000	+ .000 / - .002	1.500	+ .001 / - .001	0.312	4700J01000
1.125	+ .000 / - .002	1.625	+ .001 / - .001	0.312	4700J01125
1.250	+ .000 / - .002	1.750	+ .001 / - .001	0.312	4700J01250
1.375	+ .000 / - .002	1.875	+ .001 / - .001	0.312	4700J01375
1.500	+ .000 / - .002	2.000	+ .001 / - .001	0.312	4700J01500
1.750	+ .000 / - .002	2.250	+ .001 / - .001	0.312	4700J01750
2.000	+ .000 / - .002	2.500	+ .001 / - .001	0.312	4700J02000
2.125	+ .000 / - .002	2.625	+ .001 / - .001	0.312	4700J02125
2.250	+ .000 / - .002	2.750	+ .001 / - .001	0.312	4700J02250
2.375	+ .000 / - .002	2.875	+ .001 / - .001	0.312	4700J02375
2.500	+ .000 / - .002	3.000	+ .001 / - .001	0.312	4700J02500
2.625	+ .000 / - .002	3.125	+ .001 / - .001	0.312	4700J02625
2.750	+ .000 / - .002	3.250	+ .001 / - .001	0.312	4700J02750
3.000	+ .000 / - .002	3.500	+ .001 / - .001	0.312	4700J03000
3.250	+ .000 / - .002	3.875	+ .001 / - .001	0.312	4700J03250
3.500	+ .000 / - .002	4.125	+ .001 / - .001	0.312	4700J03500
3.750	+ .000 / - .002	4.375	+ .001 / - .001	0.312	4700J03750
4.000	+ .000 / - .002	4.625	+ .001 / - .001	0.312	4700J04000
4.250	+ .000 / - .002	4.875	+ .001 / - .001	0.312	4700J04250
4.500	+ .000 / - .002	5.125	+ .001 / - .001	0.312	4700J04500
5.000	+ .000 / - .002	5.625	+ .001 / - .001	0.312	4700J05000
5.500	+ .000 / - .002	6.125	+ .001 / - .001	0.312	4700J05500

Above table reflects recommended cross-sections for rod diameters shown. For alternate cross-sections and additional sizes, contact your Parker representative for assistance.



AY Profile

The AY profile can be used as a light to heavy duty wiper. When used in high pressure applications with the proper Parker rod seals, the AY profile complements the sealing system by providing an additional beveled sealing lip, yielding excellent film-breaking and the driest rod sealing available. Knife-trimmed sealing lips ensure the best possible film breaking.

IMPORTANT: It is important to select a rod seal profile that enables pressure relief of fluid into the system, otherwise a pressure trap may form between the wiper and rod seal. Suggested rod profile is BT U-cup.

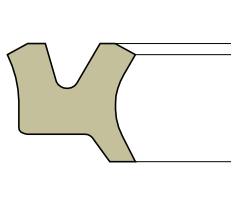
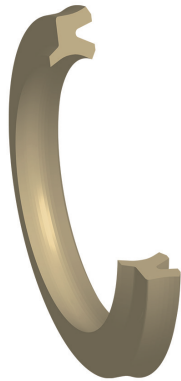

AY Cross-Section

- Premium Resilon® polyurethane
- Double-lip profile provides redundant sealing for improved leakage control
- Aggressive wiping lip excludes contaminants
- Ideal for light- to heavy-duty service

RANGE OF APPLICATION

Standard Material*	Temperature	Speed
P4300A90	-65°F to +275°F (-54°C to +135°C)	< 1.6 ft/s (0.5 m/s)
Additional Material		
P4301A90	-35°F to +225°F (-37°C to +107°C)	< 1.6 ft/s (0.5 m/s)

**Alternate Materials: For applications that may require an alternate material, please contact your local Parker seal representative.*

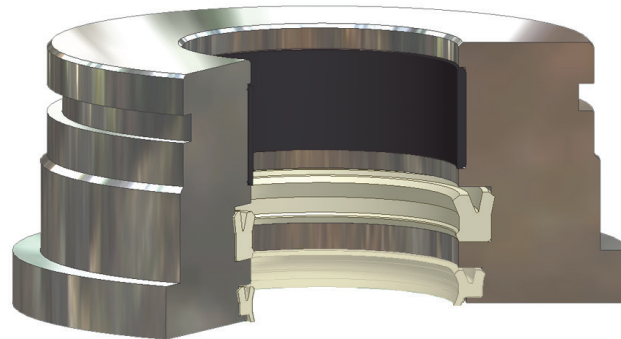

AY installed in Rod Gland

AY Profile

PART NUMBER NOMENCLATURE

AY Profile — Inch

4 3 0 0	AY	0 1 7 5 0
Seal Compound 4-Digit Material Code Example: 4300 = 90A Resilon® Polyurethane	Profile	Nominal Rod Diameter (x1000) Example: 1.75" x 1000 = 01750 5 Digits. Add leading zeros if needed.

GLAND DIMENSIONS — AY Profile

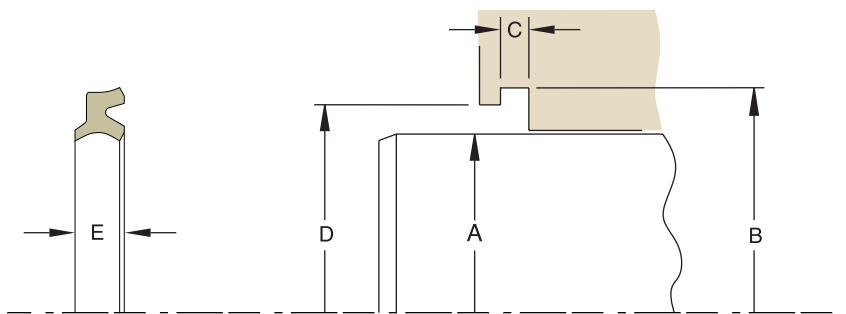

Please refer to the [Engineering Section](#) for surface finish and additional hardware considerations.

GLAND DIMENSIONS — AY Profile — Inch

A Rod Diameter		B Groove Diameter		C Groove Width	D Shoulder Diameter		E Max. Wiper Axial Width	Part Number
Dia.	Tol.	Dia.	Tol.	+ .005/- .000	Dia.	Tol.		
0.250	+ .000/- .001	0.552	+ .002/- .000	0.203	0.370	+ .002/- .000	0.245	4300AY00250
0.312	+ .000/- .001	0.615	+ .002/- .000	0.203	0.432	+ .002/- .000	0.245	4300AY00312
0.375	+ .000/- .001	0.677	+ .002/- .000	0.203	0.495	+ .002/- .000	0.245	4300AY00375
0.437	+ .000/- .001	0.740	+ .002/- .000	0.203	0.557	+ .002/- .000	0.245	4300AY00437
0.500	+ .000/- .001	0.802	+ .002/- .000	0.203	0.620	+ .002/- .000	0.245	4300AY00500
0.562	+ .000/- .001	0.865	+ .002/- .000	0.203	0.682	+ .002/- .000	0.245	4300AY00562
0.750	+ .000/- .001	1.052	+ .002/- .000	0.203	0.870	+ .002/- .000	0.245	4300AY00750
0.812	+ .000/- .001	1.177	+ .002/- .000	0.218	0.947	+ .002/- .000	0.275	4300AY00812
0.875	+ .000/- .001	1.240	+ .002/- .000	0.218	1.010	+ .002/- .000	0.275	4300AY00875

Above table reflects recommended cross-sections for rod diameters shown. Alternate cross-sections and additional sizes may be considered. Consult your Parker representative for assistance.



AY Profile

GLAND DIMENSIONS — AY Profile — Inch (cont'd)

A Rod Diameter		B Groove Diameter		C Groove Width	D Shoulder Diameter		E Max. Wiper Axial Width	Part Number
Dia.	Tol.	Dia.	Tol.	+ .005/- .000	Dia.	Tol.		
1.000	+ .000/- .002	1.365	+ .002/- .000	0.218	1.135	+ .002/- .000	0.275	4300AY01000
1.125	+ .000/- .002	1.490	+ .002/- .000	0.218	1.260	+ .002/- .000	0.275	4300AY01125
1.250	+ .000/- .002	1.615	+ .002/- .000	0.218	1.385	+ .002/- .000	0.275	4300AY01250
1.375	+ .000/- .002	1.740	+ .002/- .000	0.218	1.510	+ .002/- .000	0.275	4300AY01375
1.500	+ .000/- .002	1.865	+ .002/- .000	0.218	1.635	+ .002/- .000	0.275	4300AY01500
1.625	+ .000/- .002	1.990	+ .002/- .000	0.218	1.760	+ .002/- .000	0.275	4300AY01625
1.750	+ .000/- .002	2.115	+ .002/- .000	0.218	1.885	+ .002/- .000	0.275	4300AY01750
1.812	+ .000/- .002	2.177	+ .002/- .000	0.218	1.947	+ .002/- .000	0.275	4300AY01812
1.875	+ .000/- .002	2.240	+ .002/- .000	0.218	2.010	+ .002/- .000	0.275	4300AY01875
2.000	+ .000/- .002	2.365	+ .002/- .000	0.218	2.135	+ .002/- .000	0.275	4300AY02000
2.125	+ .000/- .002	2.490	+ .003/- .000	0.218	2.260	+ .003/- .000	0.275	4300AY02125
2.250	+ .000/- .002	2.745	+ .003/- .000	0.281	2.385	+ .003/- .000	0.351	4300AY02250
2.375	+ .000/- .002	2.870	+ .003/- .000	0.281	2.510	+ .003/- .000	0.351	4300AY02375
2.500	+ .000/- .002	2.995	+ .003/- .000	0.281	2.635	+ .003/- .000	0.351	4300AY02500
2.750	+ .000/- .002	3.245	+ .003/- .000	0.281	2.885	+ .003/- .000	0.351	4300AY02750
3.000	+ .000/- .002	3.495	+ .003/- .000	0.281	3.135	+ .003/- .000	0.351	4300AY03000
3.125	+ .000/- .002	3.620	+ .003/- .000	0.281	3.260	+ .003/- .000	0.351	4300AY03125
3.500	+ .000/- .002	3.995	+ .003/- .000	0.281	3.635	+ .003/- .000	0.351	4300AY03500
3.750	+ .000/- .002	4.245	+ .003/- .000	0.281	3.885	+ .003/- .000	0.351	4300AY03750
4.000	+ .000/- .002	4.495	+ .003/- .000	0.281	4.135	+ .003/- .000	0.351	4300AY04000
4.250	+ .000/- .002	4.745	+ .003/- .000	0.281	4.385	+ .003/- .000	0.351	4300AY04250
4.500	+ .000/- .002	4.995	+ .003/- .000	0.281	4.635	+ .003/- .000	0.351	4300AY04500
4.750	+ .000/- .002	5.245	+ .003/- .000	0.281	4.885	+ .003/- .000	0.351	4300AY04750
5.000	+ .000/- .002	5.495	+ .003/- .000	0.281	5.135	+ .003/- .000	0.351	4300AY05000
5.500	+ .000/- .002	5.995	+ .003/- .000	0.281	5.635	+ .003/- .000	0.351	4300AY05500
5.750	+ .000/- .002	6.245	+ .003/- .000	0.281	5.885	+ .003/- .000	0.351	4300AY05750
6.000	+ .000/- .002	6.495	+ .003/- .000	0.281	6.135	+ .003/- .000	0.351	4300AY06000
6.250	+ .000/- .002	6.745	+ .003/- .000	0.281	6.385	+ .003/- .000	0.351	4300AY06250
6.500	+ .000/- .002	6.995	+ .003/- .000	0.281	6.635	+ .003/- .000	0.351	4300AY06500
7.000	+ .000/- .002	7.495	+ .003/- .000	0.281	7.135	+ .003/- .000	0.351	4300AY07000
7.500	+ .000/- .003	7.995	+ .003/- .000	0.281	7.635	+ .003/- .000	0.351	4300AY07500
8.000	+ .000/- .003	8.495	+ .003/- .000	0.281	8.135	+ .003/- .000	0.351	4300AY08000
8.500	+ .000/- .003	8.995	+ .003/- .000	0.281	8.635	+ .003/- .000	0.351	4300AY08500
9.000	+ .000/- .003	9.495	+ .003/- .000	0.281	9.135	+ .003/- .000	0.351	4300AY09000
9.500	+ .000/- .003	9.995	+ .003/- .000	0.281	9.635	+ .003/- .000	0.351	4300AY09500
10.000	+ .000/- .003	10.495	+ .003/- .000	0.281	10.135	+ .003/- .000	0.351	4300AY10000

Above table reflects recommended cross-sections for rod diameters shown. Alternate cross-sections and additional sizes may be considered. Consult your Parker representative for assistance.



AY Metric Profile

PART NUMBER NOMENCLATURE

AY Profile — Metric

M 3 0 0	AY	0 4 . 0	0 4 5	-	4 . 5
Seal Compound 4-Digit Material Code (First digit "4" of 4300 replaced with "M" for metric)	Profile	Gland Depth (mm) or Seal Nom. Radial Cross-section Example: 04.0 = 4.0 mm	Seal Nom. ID (mm) Example: 035 = 35 mm		Seal Nom. Width (mm) Example: 035 = 35 mm

GLAND DIMENSIONS — AY Metric Profile

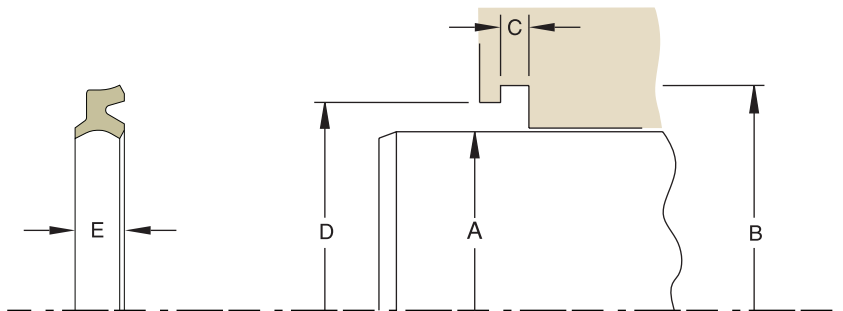

Please refer to the [Engineering Section](#) for surface finish and additional hardware considerations.

GLAND DIMENSIONS and PART NUMBER — AY Profile — Metric

A Rod Diameter		B Groove Diameter		C Groove Width	D Shoulder Diameter		E Wiper Axial Width	ISO*	Part Number
Dia.	Tol. (f7)	Dia.	Tol. (H9)	+ .13/- .00	Dia.	Tol. (H9)			
20	-.02/-.04	26	+.05/- .00	4.0	22.5	+.05/- .00	4.8	•	M300AY03.0020-3.6
25	-.02/-.04	31	+.06/- .00	4.0	27.5	+.05/- .00	4.8	•	M300AY03.0025-3.6
28	-.02/-.04	36	+.06/- .00	5.0	31.0	+.06/- .00	5.8	•	M300AY04.0028-4.5
32	-.03/-.05	40	+.06/- .00	5.0	35.0	+.06/- .00	5.8	•	M300AY04.0032-4.5
36	-.03/-.05	44	+.06/- .00	5.0	39.0	+.06/- .00	5.8	•	M300AY04.0036-4.5
40	-.03/-.05	48	+.06/- .00	5.0	43.0	+.06/- .00	5.8	•	M300AY04.0040-4.5
45	-.03/-.05	53	+.07/- .00	5.0	48.0	+.06/- .00	5.8	•	M300AY04.0045-4.5
50	-.03/-.05	58	+.07/- .00	5.0	53.0	+.07/- .00	5.8	•	M300AY04.0050-5.0
55	-.03/-.06	65	+.07/- .00	5.0	58.0	+.07/- .00	5.8	•	M300AY05.0055-4.5
55	-.03/-.06	65	+.07/- .00	6.0	58.0	+.07/- .00	6.8	•	M300AY05.0055-5.3
56	-.03/-.06	66	+.07/- .00	6.0	59.0	+.07/- .00	6.8	•	M300AY05.0056-5.3
63	-.03/-.06	73	+.07/- .00	6.0	66.0	+.07/- .00	6.8	•	M300AY05.0063-5.3
64	-.03/-.06	74	+.07/- .00	6.0	67.0	+.07/- .00	6.8	•	M300AY05.0064-5.3
70	-.03/-.06	80	+.07/- .00	6.0	73.0	+.07/- .00	6.8	•	M300AY05.0070-5.3
75	-.03/-.06	85	+.09/- .00	6.0	78.0	+.07/- .00	6.8	•	M300AY05.0075-5.3
80	-.03/-.06	90	+.09/- .00	6.0	83.0	+.09/- .00	6.8	•	M300AY05.0080-5.3
90	-.03/-.07	100	+.09/- .00	6.0	93.0	+.09/- .00	6.8	•	M300AY05.0090-5.3
100	-.03/-.07	110	+.09/- .00	6.0	103.0	+.09/- .00	6.8	•	M300AY05.0100-5.3
110	-.03/-.07	125	+.10/- .00	8.5	114.0	+.09/- .00	9.5	•	M300AY07.5110-7.5
120	-.03/-.07	135	+.10/- .00	8.5	124.0	+.10/- .00	9.5	•	M300AY07.5120-7.5
125	-.04/-.08	140	+.10/- .00	8.5	129.0	+.10/- .00	9.5	•	M300AY07.5125-7.5
140	-.04/-.08	155	+.10/- .00	8.5	144.0	+.10/- .00	9.5	•	M300AY07.5140-7.5
160	-.04/-.08	175	+.10/- .00	8.5	164.0	+.10/- .00	9.5	•	M300AY07.5160-7.5

*DIN ISO 6195, Type C, for ISO 6020-2 cylinders



AD Profile

The Parker AD profile is a double acting wiper for use in low to medium duty hydraulic cylinders. It is a two-piece design comprised of a filled PTFE cap that is energized by a standard size O-ring. The wiping and sealing design of the AD profile assists the primary rod seal in preventing leakage by helping seal fluid in the cylinder when the rod extends. When the cylinder rod retracts, the outside sealing edge prevents contamination from entering the system. Parker's AD profile will retrofit non-Parker wipers of similar design.

The AD profile may be ordered without the energizer by omitting the energizer code.



RANGE OF APPLICATION

Standard Material

Cap
0401
40% bronze-filled PTFE

Energizer
A, 70A Nitrile

Temperature*
-30°F to +250°F
(-34°C to +121°C)

Speed
< 13 ft/s
(4 m/s)

**The temperature range of the AD profile is limited by the elastomer energizer. A wider temperature range can be achieved by using alternate energizer compounds.*

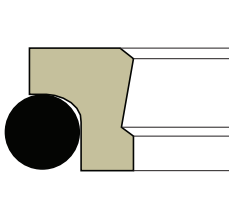

Standard AD Cross-Section

- Double acting
- Low- to medium-duty hydraulics
- Low friction PTFE
- Retrofits non-Parker wipers of similar design

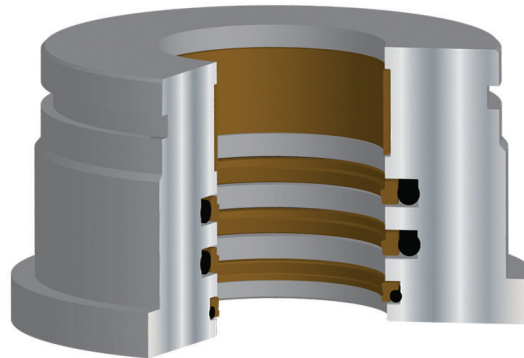

AD installed in Rod Gland



AD Profile

PART NUMBER NOMENCLATURE

AD Profile – Inch

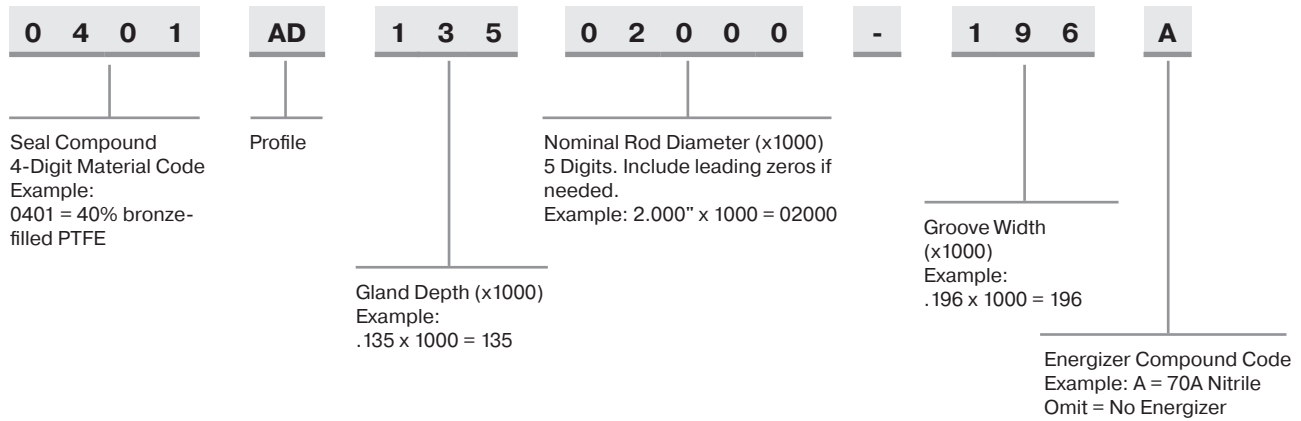

GLAND DIMENSIONS – AD Profile

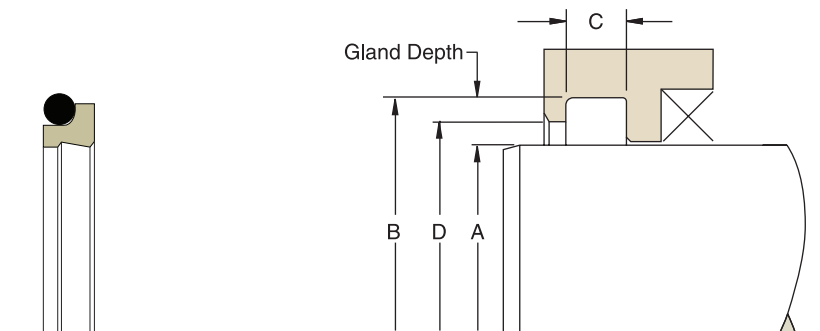

Please refer to the [Engineering Section](#) for surface finish and additional hardware considerations.

AD Profile

GLAND DIMENSIONS — AD Profile — Inch

Hardware Dimensions							O-Ring Dash Number	Part Number
A Rod Diameter		B Groove Diameter		C Groove Width	D Shoulder Diameter			
Dia.	Tol.	Dia.	Tol.	+ .008/- .000	Dia.	Tol.		
0.250	+ .000/- .002	0.440	+ .002/- .000	0.146	0.310	+ .004/- .000	011	0401AD09500250-146A
0.312	+ .000/- .002	0.502	+ .002/- .000	0.146	0.372	+ .004/- .000	012	0401AD09500312-146A
0.375	+ .000/- .002	0.565	+ .002/- .000	0.146	0.435	+ .004/- .000	013	0401AD09500375-146A
0.437	+ .000/- .002	0.627	+ .002/- .000	0.146	0.497	+ .004/- .000	014	0401AD09500437-146A
0.500	+ .000/- .002	0.690	+ .002/- .000	0.146	0.560	+ .004/- .000	015	0401AD09500500-146A
0.625	+ .000/- .003	0.895	+ .003/- .000	0.196	0.685	+ .006/- .000	115	0401AD13500625-196A
0.750	+ .000/- .003	1.020	+ .003/- .000	0.196	0.810	+ .006/- .000	117	0401AD13500750-196A
0.875	+ .000/- .003	1.145	+ .003/- .000	0.196	0.935	+ .006/- .000	119	0401AD13500875-196A
1.000	+ .000/- .003	1.270	+ .003/- .000	0.196	1.060	+ .006/- .000	121	0401AD13501000-196A
1.125	+ .000/- .003	1.395	+ .003/- .000	0.196	1.185	+ .006/- .000	123	0401AD13501125-196A
1.250	+ .000/- .003	1.520	+ .003/- .000	0.196	1.310	+ .006/- .000	125	0401AD13501250-196A
1.375	+ .000/- .003	1.645	+ .003/- .000	0.196	1.435	+ .006/- .000	127	0401AD13501375-196A
1.500	+ .000/- .003	1.770	+ .003/- .000	0.196	1.560	+ .006/- .000	129	0401AD13501500-196A
1.625	+ .000/- .003	1.895	+ .003/- .000	0.196	1.685	+ .006/- .000	131	0401AD13501625-196A
1.750	+ .000/- .003	2.020	+ .003/- .000	0.196	1.810	+ .006/- .000	133	0401AD13501750-196A
1.875	+ .000/- .003	2.145	+ .003/- .000	0.196	1.935	+ .006/- .000	135	0401AD13501875-196A
2.000	+ .000/- .003	2.270	+ .003/- .000	0.196	2.060	+ .006/- .000	137	0401AD13502000-196A
2.125	+ .000/- .003	2.395	+ .003/- .000	0.196	2.185	+ .006/- .000	139	0401AD13502125-196A
2.250	+ .000/- .003	2.520	+ .003/- .000	0.196	2.310	+ .006/- .000	141	0401AD13502250-196A
2.375	+ .000/- .003	2.645	+ .003/- .000	0.196	2.435	+ .006/- .000	143	0401AD13502375-196A
2.500	+ .000/- .003	2.770	+ .003/- .000	0.196	2.560	+ .006/- .000	145	0401AD13502500-196A

Above table reflects recommended cross-sections for rod diameters shown. Alternate cross-sections and additional sizes may be considered.
Consult your Parker representative for assistance.



AD Profile

GLAND DIMENSIONS — AD Profile — Inch (cont'd)

Hardware Dimensions							O-Ring Dash Number	Part Number
A Rod Diameter		B Groove Diameter		C Groove Width	D Shoulder Diameter			
Dia.	Tol.	Dia.	Tol.	+ .008/- .000	Dia.	Tol.		
2.625	+ .000/- .004	2.969	+ .004/- .000	0.236	2.685	+ .008/- .000	232	0401AD17202625-236A
2.750	+ .000/- .004	3.094	+ .004/- .000	0.236	2.810	+ .008/- .000	233	0401AD17202750-236A
2.875	+ .000/- .004	3.219	+ .004/- .000	0.236	2.935	+ .008/- .000	234	0401AD17202875-236A
3.000	+ .000/- .004	3.344	+ .004/- .000	0.236	3.060	+ .008/- .000	235	0401AD17203000-236A
3.125	+ .000/- .004	3.469	+ .004/- .000	0.236	3.185	+ .008/- .000	236	0401AD17203125-236A
3.250	+ .000/- .004	3.594	+ .004/- .000	0.236	3.310	+ .008/- .000	237	0401AD17203250-236A
3.375	+ .000/- .004	3.719	+ .004/- .000	0.236	3.435	+ .008/- .000	238	0401AD17203375-236A
3.500	+ .000/- .004	3.844	+ .004/- .000	0.236	3.560	+ .008/- .000	239	0401AD17203500-236A
3.625	+ .000/- .004	3.969	+ .004/- .000	0.236	3.685	+ .008/- .000	240	0401AD17203625-236A
3.750	+ .000/- .004	4.094	+ .004/- .000	0.236	3.810	+ .008/- .000	241	0401AD17203750-236A
3.875	+ .000/- .004	4.219	+ .004/- .000	0.236	3.935	+ .008/- .000	242	0401AD17203875-236A
4.000	+ .000/- .004	4.344	+ .004/- .000	0.236	4.060	+ .008/- .000	243	0401AD17204000-236A
4.250	+ .000/- .004	4.594	+ .004/- .000	0.236	4.310	+ .008/- .000	245	0401AD17204250-236A
4.500	+ .000/- .004	4.844	+ .004/- .000	0.236	4.560	+ .008/- .000	247	0401AD17204500-236A
4.750	+ .000/- .004	5.094	+ .004/- .000	0.236	4.810	+ .008/- .000	249	0401AD17204750-236A
5.000	+ .000/- .004	5.344	+ .004/- .000	0.236	5.060	+ .008/- .000	251	0401AD17205000-236A
5.250	+ .000/- .004	5.594	+ .004/- .000	0.236	5.310	+ .008/- .000	253	0401AD17205250-236A
5.500	+ .000/- .004	5.844	+ .004/- .000	0.236	5.560	+ .008/- .000	255	0401AD17205500-236A
5.750	+ .000/- .004	6.094	+ .004/- .000	0.236	5.810	+ .008/- .000	257	0401AD17205750-236A
6.000	+ .000/- .004	6.344	+ .004/- .000	0.236	6.060	+ .008/- .000	258	0401AD17206000-236A
6.250	+ .000/- .004	6.594	+ .004/- .000	0.236	6.310	+ .008/- .000	259	0401AD17206250-236A
6.500	+ .000/- .004	6.844	+ .004/- .000	0.236	6.560	+ .008/- .000	260	0401AD17206500-236A
6.750	+ .000/- .004	7.094	+ .004/- .000	0.236	6.810	+ .008/- .000	261	0401AD17206750-236A
7.000	+ .000/- .004	7.344	+ .004/- .000	0.236	7.060	+ .008/- .000	262	0401AD17207000-236A
7.250	+ .000/- .004	7.594	+ .004/- .000	0.236	7.310	+ .008/- .000	263	0401AD17207250-236A
7.500	+ .000/- .004	7.844	+ .004/- .000	0.236	7.560	+ .008/- .000	264	0401AD17207500-236A
7.750	+ .000/- .004	8.094	+ .004/- .000	0.236	7.810	+ .008/- .000	265	0401AD17207750-236A
8.000	+ .000/- .004	8.344	+ .004/- .000	0.236	8.060	+ .008/- .000	266	0401AD17208000-236A
8.250	+ .000/- .004	8.594	+ .004/- .000	0.236	8.310	+ .008/- .000	267	0401AD17208250-236A
8.500	+ .000/- .004	8.844	+ .004/- .000	0.236	8.560	+ .008/- .000	268	0401AD17208500-236A
8.750	+ .000/- .004	9.094	+ .004/- .000	0.236	8.810	+ .008/- .000	269	0401AD17208750-236A
9.000	+ .000/- .004	9.344	+ .004/- .000	0.236	9.060	+ .008/- .000	270	0401AD17209000-236A



Above table reflects recommended cross-sections for rod diameters shown. Alternate cross-sections and additional sizes may be considered. Consult your Parker representative for assistance.



WPT, WRT and PDW profiles are installed to prevent damage caused by metal-to-metal contact between components, especially in cases where the cylinder is oriented horizontally or the rod is eccentrically loaded.

Wear bands require larger clearances between metal components to function properly, reducing the pressure rating of seals. Tight-tolerance WPT and WRT profiles are precision molded, which allows for smaller extrusion gaps, thus protecting the seals under high pressure.

WEAR RING PROFILES

Profile	Cross Section	Description	Standard Material		Page
			4778	0307	
WPT		Tight tolerance piston wear ring	•		77
WRT		Tight tolerance rod wear ring	•		80
PDW		Machined PTFE wear rings for rod and piston		•	83

FEATURES, ADVANTAGES and BENEFITS

Feature	Advantage	Benefit
Dynamic bearing surface contact	Eliminates metal-to-metal contact between components	Prevents rod, piston and seal damage due to scoring and reduces warranty costs
Precision manufactured cross-section	Enables tighter hardware clearances than conventional wear rings	Increases seal life by reducing extrusion gaps associated with conventional wear rings
Low-friction, premium materials	Reduces frictional heat build-up	Lowers operating temperature and increases seal life
Precise flatness on bearing surface	Maximizes bearing contact area and compressive strength, eliminating the “dog bone” effect of conventional net-molded wear rings.	Prolongs cylinder life through uniform sideload resistance
Advanced, high performance, polymeric materials	Metal particulates and other contaminants can be imbedded in the wear ring material	Protects seals from contamination



FAQs

There are many factors to consider when designing a system. Following are the frequently asked questions regarding bearing design and choosing the right wear ring.

WHAT IS THE PERFORMANCE DIFFERENCE BETWEEN STANDARD-TOLERANCE AND TIGHT-TOLERANCE WEAR RINGS?

Standard-tolerance wear rings have a radial wall tolerance that is held to $\pm 0.0025"$, while Parker WPT and WRT tight-tolerance wear rings are held to $\pm 0.001"$ (under 6" diameter). Tight-tolerance wear rings allow for a more precise fit of components, resulting in less dimensional "play." This allows the extrusion gap to be smaller for tight-tolerance wear rings, thus increasing the seal's pressure rating beyond that of standard-tolerance wear rings. This becomes especially important at high temperatures, where the pressure rating of seal materials is further reduced.

WEAR RING GROOVES CALL FOR LARGER EXTRUSION GAPS. HOW DOES THIS AFFECT THE SEALS' PRESSURE RATING?

Since wear rings compress under heavy loading, the hardware clearances must increase to prevent metal-to-metal contact. This creates a larger extrusion gap, and as a result, the seals' pressure ratings will decrease. Pre-established gland dimensions outlined in this catalog always result in a maximum 0.005" radial clearance for metal components. As such, standard-tolerance wear rings can reduce a seal's pressure capability by 50%. Using tight-tolerance wear rings enables the extrusion gaps to be held closer, and the seal's pressure ratings are only reduced by 30%. In either case, it is important to select proper seal and back-up materials to accommodate

the increased extrusion gaps. See the chart below for more information.

HOW IS A PROPER BEARING WIDTH SELECTED?

When selecting the width of your wear ring, it is crucial to evaluate the side loads that the rings will have to withstand. Figure 1 shows the total pressure area, A_p , that a radial force from a side load will affect. Area, A_p is calculated as follows:

$$A_p = \varnothing D \times W$$

where D is the bearing O.D. for pistons or the bearing I.D. for rods, and W is the bearing width.

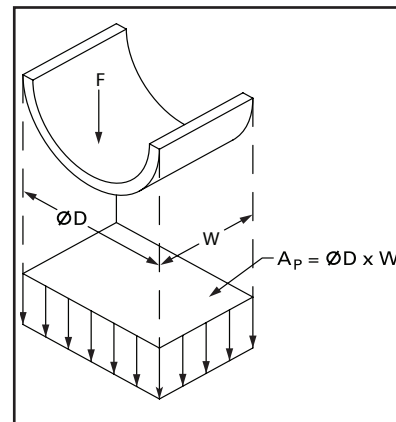
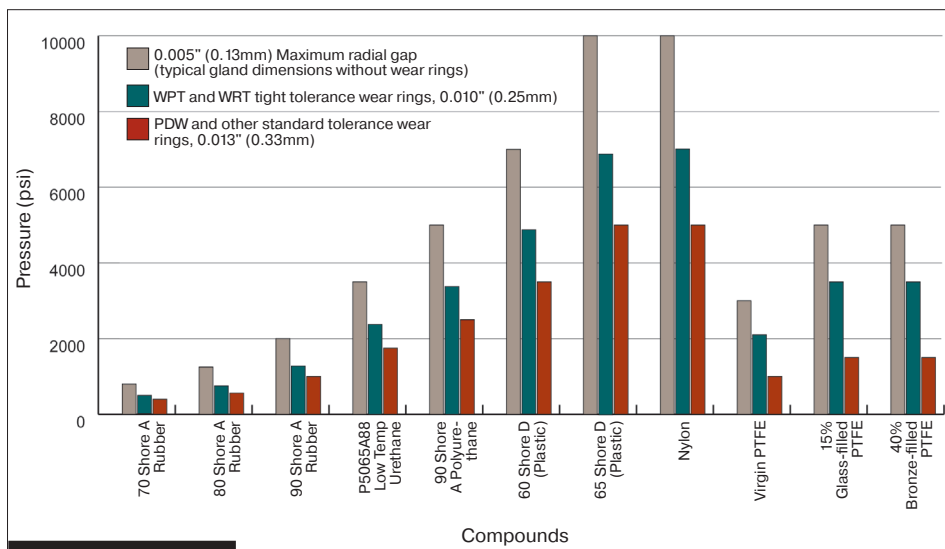

Figure 1: Total affected pressure area, A_p

Figure 2: Typical Pressure Ratings for Standard Seal Compounds in Reciprocating Applications at +160°F (see Note)



Note: Pressure ratings are based upon a test temperature of +160°F (+70°C). Lower temperatures will increase a material's pressure rating. Higher temperatures will decrease pressure ratings. Maximum radial gap is equal to the diametrical gap when wear rings are not used. Wear rings keep hardware concentric, but increase extrusion gaps to keep metal-to-metal contact from occurring, thereby decreasing pressure ratings when used.

FAQs

It is important to note that the pressure distribution will not be equally dispersed across this area. Instead, the pressure profile takes the form shown in Figure 3. The assumed load-bearing area, A_L , can be calculated as follows:

$$A_L = \frac{A_p}{5} = \frac{\text{Ø}D \times W}{5}$$

To calculate the allowable radial force, F , simply multiply the load-bearing area, A_L , by the permissible compressive load (compressive strength) of the material, q , and divide by the desired factor of safety, FS .

To calculate the proper bearing width, W , based on a known radial force: _____

$$W = \frac{5 \times F}{\text{Ø}D \times q} \times FS$$

Once W is calculated, round up to the next nominal width (1/8" increments).

To calculate the allowable radial force, F , based on a known bearing width:

$$F = \frac{A_L \times q}{FS} = \frac{\text{Ø}D \times W \times q}{5 \times FS}$$

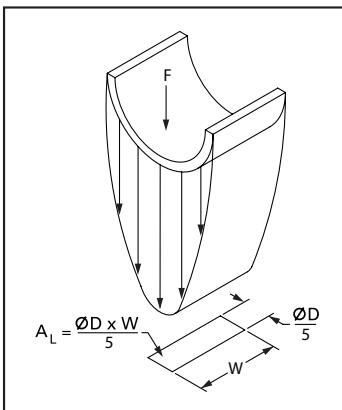

Figure 3: Load distribution of radial force, F , and effective load area, A_L

Compressive Strength, q , can be found in the material properties tables on the next page. This value is based upon known material deflection at 73°F and at a specified load. Parker recommends a factor of safety, FS , of at least 3 to account for changes in physical properties due to increases in system temperature. If additional assistance is required, please contact Parker or your authorized distributor.

WHERE SHOULD THE WEAR RING BE INSTALLED RELATIVE TO THE SEALS?

Wear rings should always be installed on the lubrication (wet) side of the seal for best performance. For rod glands, the wear ring should be on the pressure side of the rod seal. For pistons, if only one bearing is to be used, it should be on the side of the piston opposite the rod. This arrangement keeps the piston wear ring further away from the rod wear ring. This becomes critical when the rod is at full extension and provides better leveraging of the two bearing surfaces.

WHICH END CUT SHOULD BE USED?

There are two types of end cuts available: butt cut and angle cut (skive cut). The butt cut is the most common and most economical cut. Angle cuts provide added performance by ensuring bearing area overlap at the wear ring's gap. Figure 4 illustrates these options.

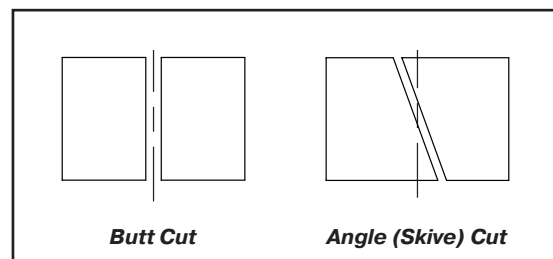

Figure 4: End cuts

Materials

Parker offers wear ring and bearing materials that are anchored by our more than 50 years of manufacturing and materials science expertise.

ENGINEERED PLASTICS: 4778

Our glass loaded 4778 material with internal lubrication for low friction, delivers best-in-class compressive modulus in a wear ring configuration. WPT and WRT Series wear rings in 4778 material withstand deflection, reduce tolerance stack-up, and maximize resistance to side load.

PTFE: CARBON-GRAPHITE FILLED 0307

Carbon reduces creep, increases hardness and elevates the thermal conductivity of PTFE. This 23% Carbon, 2% Graphite-filled PTFE compound delivers good wear resistance and performs well in non-lubricated applications.



TYPICAL PHYSICAL PROPERTIES OF W4778 ENGINEERED PLASTIC

Property	Unit	4778	Test Method
Compressive Strength, q	psi	28500	ASTM D695, 73°F
Tensile Strength	psi	29750	ASTM D638, 73°F
Flexural Strength	psi	41550	ASTM D790, 73°F
Flexural Modulus	Kpsi	1900	ASTM D790, 73°F
Water Absorption	%	0.2	24 hour immersion, ASTM D570, 73°F
Temperature Range	°F	-65 to +275	—

PHYSICAL AND MECHANICAL PROPERTIES OF 0307 PTFE

Property	Unit	0307 23% Carbon-, 2% Graphite- Filled PTFE	Test Method
Compressive Strength, q	psi	3600	ASTM D1457-81A
Tensile Strength	psi	2250	ASTM D1457-81A
Elongation	%	100	ASTM D4894
Deformation Under Load	%	2.5	ASTM D621, 24 hrs @ 2000 psi, 70°F
Coefficient of Friction	—	0.08 - 0.11	ASTM D3702
Temperature Range	°F	-250 to +575	—
Shore D Hardness	—	64	ASTM D2240-75

WPT Profile

TIGHT-TOLERANCE PISTON WEAR RING

WPT profile tight-tolerance piston wear rings are the premier bearings for light- to heavy-duty hydraulic applications. WPT profile wear rings are available in standard sizes from 1" up to 12" bore diameters (larger sizes upon request). WPT profile wear rings feature chamfered corners on the I.D. and are designed to snap closed during assembly to hold tight against the piston, eliminating bore interference and simplifying installation.

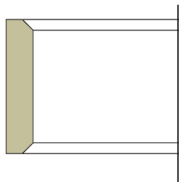
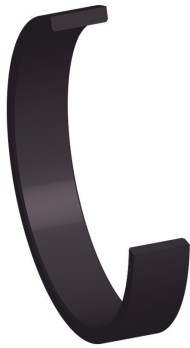

WPT Cross-Section

TECHNICAL DATA

Standard Material	Radial Cross-Section Tolerance	End Cuts
4778 Glass-loaded Nylon	+ .000" / - .002" (up to 6" O.D.); + .000" / - .003" (6" to 12" O.D.)	Butt Cut (Standard)
Additional End Cut Option: Angle Cut (Skive Cut)	Temperature - 65 to +275° F (-54 to +135°C)	Speed < 3 ft/s (1 m/s)

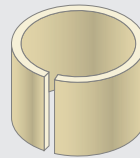

Butt Cut

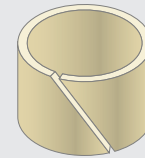

Angle Cut

- Precision radial wall tolerance reduces misalignment and prevents binding up
- Tight tolerance reduces extrusion gap for increased seal pressure capability
- Chamfers eliminate interference with groove radii
- Accommodates simplified housing design

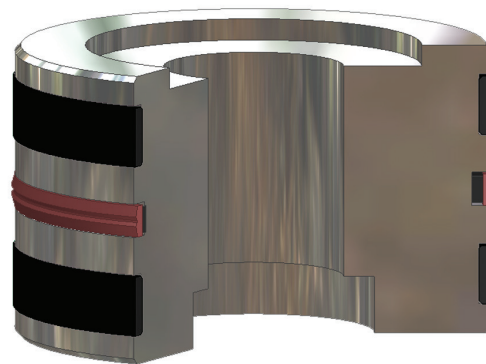

**Piston sealing system
comprised of WPT wear rings and BP bi-directional piston seal**

WPT Profile

PART NUMBER NOMENCLATURE

WPT Profile — Inch

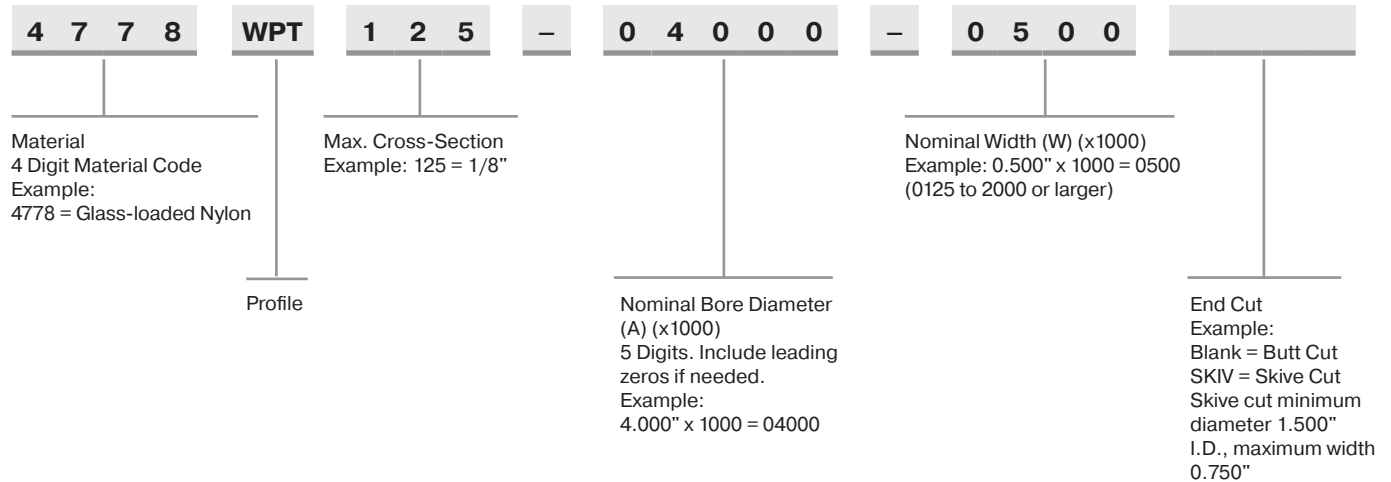

GLAND DIMENSIONS — WPT Profile

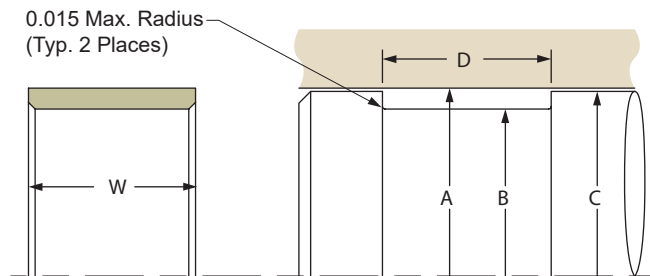

Please refer to the [Engineering Section](#) for surface finish and additional hardware considerations.

WPT Profile

GLAND DIMENSIONS – WPT Profile – Inch

Hardware Dimensions							Part Number (Alternate part widths are available—see previous page for part numbering)
A Bore Diameter		B Groove Diameter		C Piston Diameter		D Groove Width	
Dia.	Tol.	Dia.	Tol.	Dia.	Tol.	+ .010/- .000	
.062 Cross Section							
1.125	+ .002/- .000	1.000	+ .000/- .002	1.108	+ .000/- .002	0.260	4778WPT062-01125-0250
1.250	+ .002/- .000	1.125	+ .000/- .002	1.233	+ .000/- .002	0.260	4778WPT062-01250-0250
1.375	+ .002/- .000	1.250	+ .000/- .002	1.358	+ .000/- .002	0.260	4778WPT062-01375-0250
1.500	+ .002/- .000	1.375	+ .000/- .002	1.483	+ .000/- .002	0.385	4778WPT062-01500-0375
1.625	+ .002/- .000	1.374	+ .000/- .002	1.608	+ .000/- .002	0.385	4778WPT062-01625-0375
1.750	+ .002/- .000	1.499	+ .000/- .002	1.733	+ .000/- .002	0.385	4778WPT062-01750-0375
1.875	+ .002/- .000	1.624	+ .000/- .002	1.858	+ .000/- .002	0.385	4778WPT062-01875-0375
.125 Cross Section							
2.000	+ .002/- .000	1.749	+ .000/- .002	1.983	+ .000/- .002	0.510	4778WPT125-02000-0500
2.250	+ .002/- .000	1.999	+ .000/- .002	2.233	+ .000/- .002	0.510	4778WPT125-02250-0500
2.500	+ .002/- .000	2.249	+ .000/- .002	2.483	+ .000/- .002	0.510	4778WPT125-02500-0500
2.750	+ .002/- .000	2.499	+ .000/- .002	2.733	+ .000/- .002	0.510	4778WPT125-02750-0500
3.000	+ .002/- .000	2.749	+ .000/- .002	2.983	+ .000/- .002	0.510	4778WPT125-03000-0500
3.250	+ .002/- .000	2.999	+ .000/- .002	3.233	+ .000/- .002	0.510	4778WPT125-03250-0500
3.500	+ .002/- .000	3.249	+ .000/- .002	3.483	+ .000/- .002	0.510	4778WPT125-03500-0500
3.750	+ .002/- .000	3.499	+ .000/- .002	3.733	+ .000/- .002	0.510	4778WPT125-03750-0500
4.000	+ .002/- .000	3.749	+ .000/- .002	3.983	+ .000/- .002	0.510	4778WPT125-04000-0500
4.250	+ .002/- .000	3.999	+ .000/- .002	4.233	+ .000/- .002	0.510	4778WPT125-04250-0500
4.500	+ .002/- .000	4.249	+ .000/- .002	4.483	+ .000/- .002	0.510	4778WPT125-04500-0500
4.750	+ .002/- .000	4.499	+ .000/- .002	4.733	+ .000/- .002	0.510	4778WPT125-04750-0500
5.000	+ .004/- .000	4.749	+ .000/- .003	4.982	+ .000/- .003	0.510	4778WPT125-05000-0500
5.250	+ .004/- .000	4.999	+ .000/- .003	5.232	+ .000/- .003	0.510	4778WPT125-05250-0500
5.500	+ .004/- .000	5.249	+ .000/- .003	5.482	+ .000/- .003	0.510	4778WPT125-05500-0500
5.750	+ .004/- .000	5.499	+ .000/- .003	5.732	+ .000/- .003	0.510	4778WPT125-05750-0500
6.000	+ .004/- .000	5.749	+ .000/- .003	5.982	+ .000/- .003	0.760	4778WPT125-06000-0750
6.250	+ .004/- .000	5.999	+ .000/- .003	6.232	+ .000/- .003	0.760	4778WPT125-06250-0750
6.500	+ .004/- .000	6.249	+ .000/- .003	6.482	+ .000/- .003	0.760	4778WPT125-06500-0750
6.750	+ .004/- .000	6.499	+ .000/- .003	6.732	+ .000/- .003	0.760	4778WPT125-06750-0750
7.000	+ .004/- .000	6.749	+ .000/- .003	6.982	+ .000/- .003	0.760	4778WPT125-07000-0750
7.500	+ .004/- .000	7.249	+ .000/- .003	7.482	+ .000/- .003	0.760	4778WPT125-07500-0750

Above table reflects recommended cross-sections for bore diameters shown. For alternate cross-sections and additional sizes, contact your Parker representative for assistance.



WRT Profile

WRT profile tight-tolerance rod wear rings, when combined with the WPT profile, complete the premier cylinder bearing system. Recommended for light- to heavy-duty hydraulic applications, they are available in standard sizes from

7/8" up to 7" rod diameters (larger sizes upon request). WRT profile wear rings feature chamfered corners on the O.D. and are designed to snap open during assembly to hold tight against the head gland, eliminating rod interference and simplifying installation.

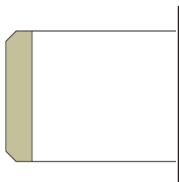

WRT Cross-Section

- Precision radial wall tolerance reduces misalignment and prevents binding up
- Tight tolerance reduces extrusion gap for increased seal pressure capability
- Chamfers eliminate interference with groove radii
- Accommodates simplified housing design

TECHNICAL DATA

Standard Material	Radial Cross-Section Tolerance	End Cuts
4778 Glass-loaded Nylon	+ .000" / - .002" (up to 5-3/4" I.D.); + .000" / - .003" (5-3/4" to 7" I.D.)	Butt Cut (Standard)
Additional End Cut Option: Angle Cut (Skive Cut)	Temperature - 65 to +275° F (-54 to +135°C)	Speed < 3 ft/s (1 m/s)

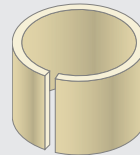

Butt Cut

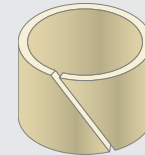

Angle Cut

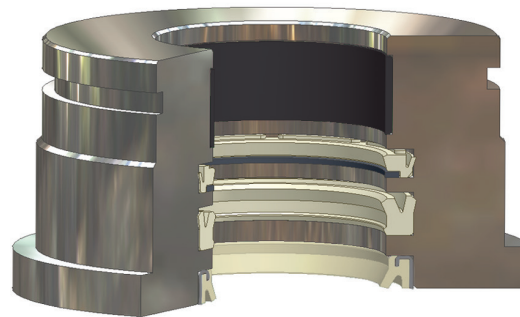

Rod sealing system comprised of WRT wear ring, BR buffer ring assembly, BT u-cup and J canned wiper

WRT Profile

PART NUMBER NOMENCLATURE

WRT Profile — Inch

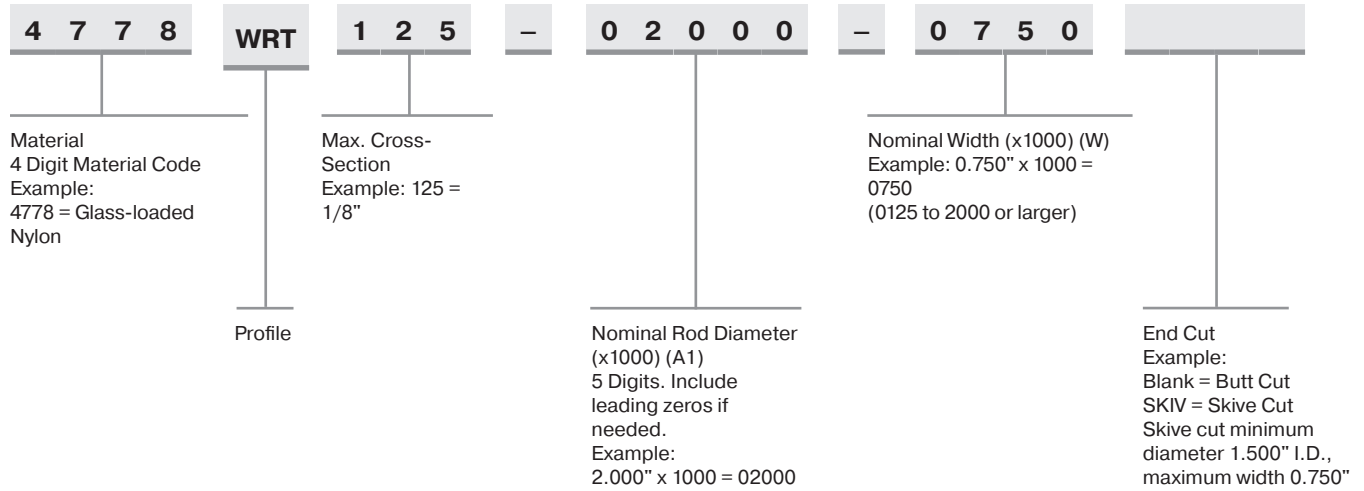

GLAND DIMENSIONS — WRT Profile

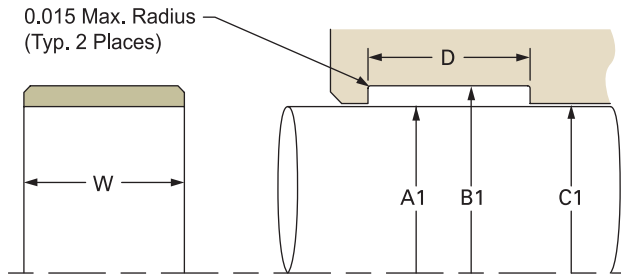

Please refer to the [Engineering Section](#) for surface finish and additional hardware considerations.

WRT Profile

GLAND DIMENSIONS — WRT Profile — Inch

Hardware Dimensions							Part Number (Alternate part widths are available—see previous page for part numbering)
A1 Rod Diameter		B1 Groove Diameter		C1 Throat Diameter		D Groove Width	
Dia.	Tol.	Dia.	Tol.	Dia.	Tol.	+ .010/- .000	
.062 Cross Section							
1.000	+ .000/- .002	1.125	+ .002/- .000	1.017	+ .002/- .000	0.260	4778WRT062-01000-0250
1.125	+ .000/- .002	1.250	+ .002/- .000	1.142	+ .002/- .000	0.260	4778WRT062-01125-0250
1.250	+ .000/- .002	1.375	+ .002/- .000	1.267	+ .002/- .000	0.385	4778WRT062-01250-0375
1.375	+ .000/- .002	1.500	+ .002/- .000	1.392	+ .002/- .000	0.385	4778WRT062-01375-0375
1.500	+ .000/- .002	1.625	+ .002/- .000	1.517	+ .002/- .000	0.385	4778WRT062-01500-0375
1.625	+ .000/- .002	1.750	+ .002/- .000	1.642	+ .002/- .000	0.385	4778WRT062-01625-0375
1.750	+ .000/- .002	1.875	+ .002/- .000	1.767	+ .002/- .000	0.385	4778WRT062-01750-0375
1.875	+ .000/- .002	2.000	+ .002/- .000	1.892	+ .002/- .000	0.385	4778WRT062-01875-0375
.125 Cross Section							
2.000	+ .000/- .002	2.251	+ .002/- .000	2.017	+ .002/- .000	0.510	4778WRT125-02000-0500
2.250	+ .000/- .002	2.501	+ .002/- .000	2.267	+ .002/- .000	0.510	4778WRT125-02250-0500
2.500	+ .000/- .002	2.751	+ .002/- .000	2.517	+ .002/- .000	0.510	4778WRT125-02500-0500
2.750	+ .000/- .002	3.001	+ .002/- .000	2.767	+ .002/- .000	0.510	4778WRT125-02750-0500
3.000	+ .000/- .002	3.251	+ .002/- .000	3.017	+ .002/- .000	0.510	4778WRT125-03000-0500
3.250	+ .000/- .002	3.501	+ .002/- .000	3.267	+ .002/- .000	0.510	4778WRT125-03250-0500
3.500	+ .000/- .002	3.751	+ .002/- .000	3.517	+ .002/- .000	0.510	4778WRT125-03500-0500
3.750	+ .000/- .002	4.001	+ .002/- .000	3.767	+ .002/- .000	0.510	4778WRT125-03750-0500
4.000	+ .000/- .002	4.251	+ .002/- .000	4.017	+ .002/- .000	0.760	4778WRT125-04000-0750
4.250	+ .000/- .002	4.501	+ .002/- .000	4.267	+ .002/- .000	0.760	4778WRT125-04250-0750
4.500	+ .000/- .002	4.751	+ .002/- .000	4.517	+ .002/- .000	0.760	4778WRT125-04500-0750
4.750	+ .000/- .002	5.001	+ .002/- .000	4.767	+ .002/- .000	0.760	4778WRT125-04750-0750
5.000	+ .000/- .002	5.251	+ .002/- .000	5.017	+ .002/- .000	0.760	4778WRT125-05000-0750
5.250	+ .000/- .002	5.501	+ .002/- .000	5.267	+ .002/- .000	0.760	4778WRT125-05250-0750
5.500	+ .000/- .002	5.751	+ .002/- .000	5.517	+ .002/- .000	0.760	4778WRT125-05500-0750
5.750	+ .000/- .004	6.001	+ .003/- .000	5.770	+ .003/- .000	0.760	4778WRT125-05750-0750
6.000	+ .000/- .004	6.251	+ .003/- .000	6.020	+ .003/- .000	0.760	4778WRT125-06000-0750
6.250	+ .000/- .004	6.501	+ .003/- .000	6.270	+ .003/- .000	0.760	4778WRT125-06250-0750
6.500	+ .000/- .004	6.751	+ .003/- .000	6.520	+ .003/- .000	0.760	4778WRT125-06500-0750
6.750	+ .000/- .004	7.001	+ .003/- .000	6.770	+ .003/- .000	0.760	4778WRT125-06750-0750
7.000	+ .000/- .004	7.251	+ .003/- .000	7.020	+ .003/- .000	0.760	4778WRT125-07000-0750

Above table reflects recommended cross-sections for rod diameters shown. For alternate cross-sections and additional sizes, contact your Parker representative for assistance.



PDW Profile

PDW profile wear rings are precision machined PTFE bearings, lathecut to exact size and shape. PDW profile wear rings offer precise fitting and easy installation. Filled PTFE material gives these machined wear rings versatility to accommodate any light-duty hydraulic application requiring low friction and high temperature capabilities.

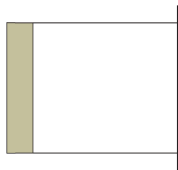

WRT Cross-Section

- Precision machined fit
- Easy to install
- Low friction PTFE material

TECHNICAL DATA

Standard Material	Radial Cross- Section Tolerance	End Cuts
0307 – 23% Carbon, 2% Graphite-Filled PTFE	+ .000"/- .004"	Butt Cut (Standard), Angle Cut (Skive Cut)
Additional materials available upon request.	Temperature -250 to +575°F (-157 to +302°C)	Speed < 13 ft/s (4 m/s)

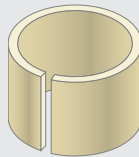

Butt Cut

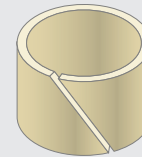

Angle Cut

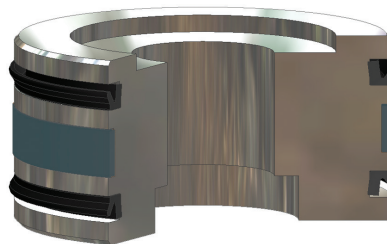

Piston sealing system utilizing PDW machined wear ring

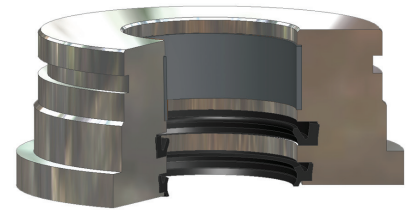

Rod sealing system utilizing PDW machined wear ring

PDW Profile

PART NUMBER NOMENCLATURE

PDW Profile – Inch

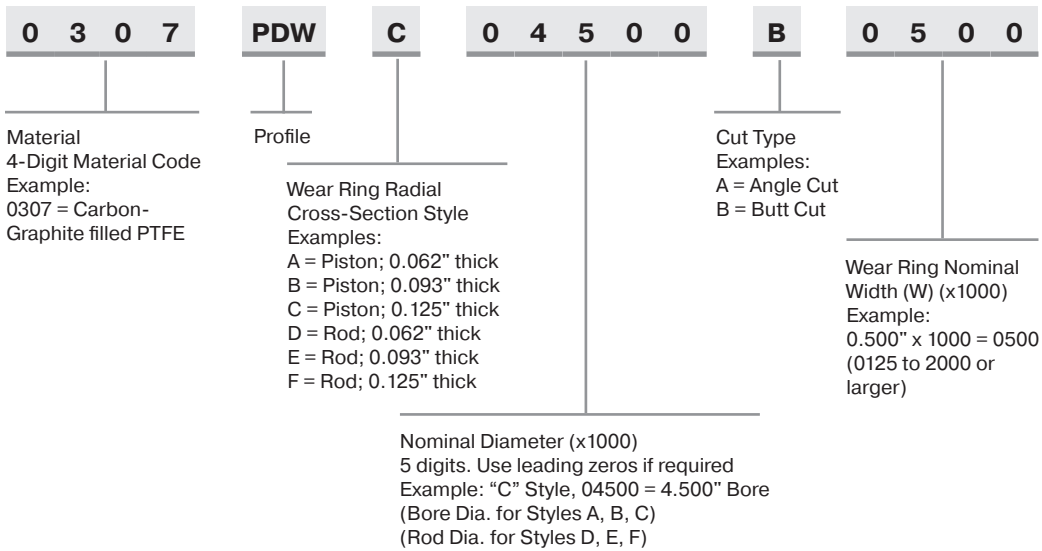

GLAND DIMENSIONS – PDW Profile, Piston

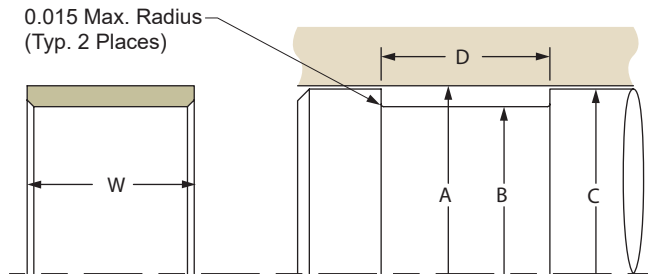

Please refer to the [Engineering Section](#) for surface finish and additional hardware considerations.

PDW Profile

GLAND DIMENSIONS — PDW Profile, Piston — Inch

A Bore Diameter		B Groove Diameter		C Piston Diameter		D Groove Width	Part Number
Dia.	Tol.	Dia.	Tol.	Dia.	Tol.	+ .010 / - .000	PDWA
0.687	+ .002 / - .000	0.562	+ .000 / - .002	0.666	+ .000 / - .002	D = W + 0.010"	0307 PDWA 00687 X XXXX
0.750	+ .002 / - .000	0.625	+ .000 / - .002	0.729	+ .000 / - .002	D = W + 0.010"	0307 PDWA 00750 X XXXX
0.812	+ .002 / - .000	0.687	+ .000 / - .002	0.791	+ .000 / - .002	D = W + 0.010"	0307 PDWA 00812 X XXXX
0.875	+ .002 / - .000	0.750	+ .000 / - .002	0.854	+ .000 / - .002	D = W + 0.010"	0307 PDWA 00875 X XXXX
0.937	+ .002 / - .000	0.812	+ .000 / - .002	0.916	+ .000 / - .002	D = W + 0.010"	0307 PDWA 00937 X XXXX
1.000	+ .002 / - .000	0.875	+ .000 / - .002	0.979	+ .000 / - .002	D = W + 0.010"	0307 PDWA 01000 X XXXX
1.062	+ .002 / - .000	0.937	+ .000 / - .002	1.041	+ .000 / - .002	D = W + 0.010"	0307 PDWA 01062 X XXXX
1.125	+ .002 / - .000	1.000	+ .000 / - .002	1.104	+ .000 / - .002	D = W + 0.010"	0307 PDWA 01125 X XXXX
1.187	+ .002 / - .000	1.062	+ .000 / - .002	1.166	+ .000 / - .002	D = W + 0.010"	0307 PDWA 01187 X XXXX
1.250	+ .002 / - .000	1.125	+ .000 / - .002	1.229	+ .000 / - .002	D = W + 0.010"	0307 PDWA 01250 X XXXX
1.312	+ .002 / - .000	1.187	+ .000 / - .002	1.291	+ .000 / - .002	D = W + 0.010"	0307 PDWA 01312 X XXXX
1.375	+ .002 / - .000	1.250	+ .000 / - .002	1.354	+ .000 / - .002	D = W + 0.010"	0307 PDWA 01375 X XXXX
1.437	+ .002 / - .000	1.312	+ .000 / - .002	1.416	+ .000 / - .002	D = W + 0.010"	0307 PDWA 01437 X XXXX
1.500	+ .002 / - .000	1.375	+ .000 / - .002	1.479	+ .000 / - .002	D = W + 0.010"	0307 PDWA 01500 X XXXX
1.562	+ .002 / - .000	1.437	+ .000 / - .002	1.541	+ .000 / - .002	D = W + 0.010"	0307 PDWA 01562 X XXXX
1.625	+ .002 / - .000	1.500	+ .000 / - .002	1.604	+ .000 / - .002	D = W + 0.010"	0307 PDWA 01625 X XXXX
1.687	+ .002 / - .000	1.562	+ .000 / - .002	1.666	+ .000 / - .002	D = W + 0.010"	0307 PDWA 01687 X XXXX
1.750	+ .002 / - .000	1.625	+ .000 / - .002	1.729	+ .000 / - .002	D = W + 0.010"	0307 PDWA 01750 X XXXX
1.875	+ .002 / - .000	1.750	+ .000 / - .002	1.854	+ .000 / - .002	D = W + 0.010"	0307 PDWA 01875 X XXXX
2.000	+ .002 / - .000	1.875	+ .000 / - .002	1.979	+ .000 / - .002	D = W + 0.010"	0307 PDWA 02000 X XXXX
Dia.	Tol.	Dia.	Tol.	Dia.	Tol.	+ .010 / - .000	PDWB
1.500	+ .002 / - .000	1.313	+ .000 / - .002	1.479	+ .000 / - .002	D = W + 0.010"	0307 PDWB 01500 X XXXX
1.562	+ .002 / - .000	1.375	+ .000 / - .002	1.541	+ .000 / - .002	D = W + 0.010"	0307 PDWB 01562 X XXXX
1.625	+ .002 / - .000	1.438	+ .000 / - .002	1.604	+ .000 / - .002	D = W + 0.010"	0307 PDWB 01625 X XXXX
1.687	+ .002 / - .000	1.500	+ .000 / - .002	1.666	+ .000 / - .002	D = W + 0.010"	0307 PDWB 01687 X XXXX
1.750	+ .002 / - .000	1.563	+ .000 / - .002	1.729	+ .000 / - .002	D = W + 0.010"	0307 PDWB 01750 X XXXX
1.875	+ .002 / - .000	1.688	+ .000 / - .002	1.854	+ .000 / - .002	D = W + 0.010"	0307 PDWB 01875 X XXXX
2.000	+ .002 / - .000	1.813	+ .000 / - .002	1.979	+ .000 / - .002	D = W + 0.010"	0307 PDWB 02000 X XXXX
2.125	+ .002 / - .000	1.938	+ .000 / - .002	2.104	+ .000 / - .002	D = W + 0.010"	0307 PDWB 02125 X XXXX
2.250	+ .002 / - .000	2.063	+ .000 / - .002	2.229	+ .000 / - .002	D = W + 0.010"	0307 PDWB 02250 X XXXX
2.375	+ .002 / - .000	2.188	+ .000 / - .002	2.354	+ .000 / - .002	D = W + 0.010"	0307 PDWB 02375 X XXXX
2.500	+ .002 / - .000	2.313	+ .000 / - .002	2.479	+ .000 / - .002	D = W + 0.010"	0307 PDWB 02500 X XXXX
2.625	+ .002 / - .000	2.438	+ .000 / - .002	2.604	+ .000 / - .002	D = W + 0.010"	0307 PDWB 02625 X XXXX
2.750	+ .002 / - .000	2.563	+ .000 / - .002	2.729	+ .000 / - .002	D = W + 0.010"	0307 PDWB 02750 X XXXX
2.875	+ .002 / - .000	2.688	+ .000 / - .002	2.854	+ .000 / - .002	D = W + 0.010"	0307 PDWB 02875 X XXXX
3.000	+ .002 / - .000	2.813	+ .000 / - .002	2.979	+ .000 / - .002	D = W + 0.010"	0307 PDWB 03000 X XXXX
3.125	+ .002 / - .000	2.938	+ .000 / - .002	3.104	+ .000 / - .002	D = W + 0.010"	0307 PDWB 03125 X XXXX



PDW Profile

GLAND DIMENSIONS — PDW Profile, Piston — Inch (cont'd)

A Bore Diameter		B Groove Diameter		C Piston Diameter		D Groove Width	Part Number
Dia.	Tol.	Dia.	Tol.	Dia.	Tol.	+ .010/- .000	PDWB
3.250	+ .002/- .000	3.063	+ .000/- .002	3.229	+ .000/- .002	D = W + 0.010"	0307 PDWB 03250 X XXXX
3.375	+ .002/- .000	3.188	+ .000/- .002	3.354	+ .000/- .002	D = W + 0.010"	0307 PDWB 03375 X XXXX
3.500	+ .002/- .000	3.313	+ .000/- .002	3.479	+ .000/- .002	D = W + 0.010"	0307 PDWB 03500 X XXXX
3.625	+ .002/- .000	3.438	+ .000/- .002	3.604	+ .000/- .002	D = W + 0.010"	0307 PDWB 03625 X XXXX
3.750	+ .002/- .000	3.563	+ .000/- .002	3.729	+ .000/- .002	D = W + 0.010"	0307 PDWB 03750 X XXXX
3.875	+ .002/- .000	3.688	+ .000/- .002	3.854	+ .000/- .002	D = W + 0.010"	0307 PDWB 03875 X XXXX
4.000	+ .002/- .000	3.813	+ .000/- .002	3.979	+ .000/- .002	D = W + 0.010"	0307 PDWB 04000 X XXXX
4.125	+ .002/- .000	3.938	+ .000/- .002	4.104	+ .000/- .002	D = W + 0.010"	0307 PDWB 04125 X XXXX
4.250	+ .002/- .000	4.063	+ .000/- .002	4.229	+ .000/- .002	D = W + 0.010"	0307 PDWB 04250 X XXXX
4.375	+ .002/- .000	4.188	+ .000/- .002	4.354	+ .000/- .002	D = W + 0.010"	0307 PDWB 04375 X XXXX
4.500	+ .002/- .000	4.313	+ .000/- .002	4.479	+ .000/- .002	D = W + 0.010"	0307 PDWB 04500 X XXXX
4.625	+ .002/- .000	4.438	+ .000/- .002	4.604	+ .000/- .002	D = W + 0.010"	0307 PDWB 04625 X XXXX
4.750	+ .002/- .000	4.563	+ .000/- .002	4.729	+ .000/- .002	D = W + 0.010"	0307 PDWB 04750 X XXXX
4.875	+ .002/- .000	4.688	+ .000/- .002	4.854	+ .000/- .002	D = W + 0.010"	0307 PDWB 04875 X XXXX
5.000	+ .002/- .000	4.813	+ .000/- .002	4.978	+ .000/- .002	D = W + 0.010"	0307 PDWB 05000 X XXXX
5.125	+ .002/- .000	4.938	+ .000/- .002	5.103	+ .000/- .002	D = W + 0.010"	0307 PDWB 05125 X XXXX
5.250	+ .002/- .000	5.063	+ .000/- .002	5.228	+ .000/- .002	D = W + 0.010"	0307 PDWB 05250 X XXXX
5.375	+ .002/- .000	5.188	+ .000/- .002	5.353	+ .000/- .002	D = W + 0.010"	0307 PDWB 05375 X XXXX
5.500	+ .002/- .000	5.313	+ .000/- .002	5.478	+ .000/- .002	D = W + 0.010"	0307 PDWB 05500 X XXXX
5.625	+ .002/- .000	5.438	+ .000/- .002	5.603	+ .000/- .002	D = W + 0.010"	0307 PDWB 05625 X XXXX
5.750	+ .002/- .000	5.563	+ .000/- .002	5.728	+ .000/- .002	D = W + 0.010"	0307 PDWB 05750 X XXXX
5.875	+ .002/- .000	5.688	+ .000/- .002	5.853	+ .000/- .002	D = W + 0.010"	0307 PDWB 05875 X XXXX
6.000	+ .002/- .000	5.813	+ .000/- .002	5.978	+ .000/- .002	D = W + 0.010"	0307 PDWB 06000 X XXXX
6.125	+ .002/- .000	5.938	+ .000/- .002	6.103	+ .000/- .002	D = W + 0.010"	0307 PDWB 06125 X XXXX
6.250	+ .002/- .000	6.063	+ .000/- .002	6.228	+ .000/- .002	D = W + 0.010"	0307 PDWB 06250 X XXXX
6.375	+ .002/- .000	6.188	+ .000/- .002	6.353	+ .000/- .002	D = W + 0.010"	0307 PDWB 06375 X XXXX
6.500	+ .002/- .000	6.313	+ .000/- .002	6.478	+ .000/- .002	D = W + 0.010"	0307 PDWB 06500 X XXXX
6.750	+ .002/- .000	6.563	+ .000/- .002	6.728	+ .000/- .002	D = W + 0.010"	0307 PDWB 06750 X XXXX
7.000	+ .002/- .000	6.813	+ .000/- .002	6.978	+ .000/- .002	D = W + 0.010"	0307 PDWB 07000 X XXXX
7.250	+ .002/- .000	7.063	+ .000/- .002	7.228	+ .000/- .002	D = W + 0.010"	0307 PDWB 07250 X XXXX
7.500	+ .002/- .000	7.313	+ .000/- .002	7.478	+ .000/- .002	D = W + 0.010"	0307 PDWB 07500 X XXXX
7.750	+ .002/- .000	7.563	+ .000/- .002	7.728	+ .000/- .002	D = W + 0.010"	0307 PDWB 07750 X XXXX
8.000	+ .006/- .000	7.813	+ .000/- .004	7.977	+ .000/- .004	D = W + 0.010"	0307 PDWB 08000 X XXXX
8.250	+ .006/- .000	8.063	+ .000/- .004	8.227	+ .000/- .004	D = W + 0.010"	0307 PDWB 08250 X XXXX
8.500	+ .006/- .000	8.313	+ .000/- .004	8.477	+ .000/- .004	D = W + 0.010"	0307 PDWB 08500 X XXXX
9.000	+ .006/- .000	8.813	+ .000/- .004	8.977	+ .000/- .004	D = W + 0.010"	0307 PDWB 09000 X XXXX
9.500	+ .006/- .000	9.313	+ .000/- .004	9.477	+ .000/- .004	D = W + 0.010"	0307 PDWB 09500 X XXXX
10.000	+ .006/- .000	9.813	+ .000/- .004	9.977	+ .000/- .004	D = W + 0.010"	0307 PDWB 10000 X XXXX



PDW Profile

GLAND DIMENSIONS — PDW Profile, Piston — Inch (cont'd)

A Bore Diameter		B Groove Diameter		C Piston Diameter		D Groove Width	Part Number
Dia.	Tol.	Dia.	Tol.	Dia.	Tol.	+ .010/- .000	PDWC
2.000	+ .002/- .000	1.749	+ .000/- .002	1.979	+ .000/- .002	D = W + 0.010"	0307 PDWC 02000 X XXXX
2.125	+ .002/- .000	1.874	+ .000/- .002	2.104	+ .000/- .002	D = W + 0.010"	0307 PDWC 02125 X XXXX
2.250	+ .002/- .000	1.999	+ .000/- .002	2.229	+ .000/- .002	D = W + 0.010"	0307 PDWC 02250 X XXXX
2.375	+ .002/- .000	2.124	+ .000/- .002	2.354	+ .000/- .002	D = W + 0.010"	0307 PDWC 02375 X XXXX
2.500	+ .002/- .000	2.249	+ .000/- .002	2.479	+ .000/- .002	D = W + 0.010"	0307 PDWC 02500 X XXXX
2.625	+ .002/- .000	2.374	+ .000/- .002	2.604	+ .000/- .002	D = W + 0.010"	0307 PDWC 02625 X XXXX
2.750	+ .002/- .000	2.499	+ .000/- .002	2.729	+ .000/- .002	D = W + 0.010"	0307 PDWC 02750 X XXXX
2.875	+ .002/- .000	2.624	+ .000/- .002	2.854	+ .000/- .002	D = W + 0.010"	0307 PDWC 02875 X XXXX
3.000	+ .002/- .000	2.749	+ .000/- .002	2.979	+ .000/- .002	D = W + 0.010"	0307 PDWC 03000 X XXXX
3.125	+ .002/- .000	2.874	+ .000/- .002	3.104	+ .000/- .002	D = W + 0.010"	0307 PDWC 03125 X XXXX
3.250	+ .002/- .000	2.999	+ .000/- .002	3.229	+ .000/- .002	D = W + 0.010"	0307 PDWC 03250 X XXXX
3.375	+ .002/- .000	3.124	+ .000/- .002	3.354	+ .000/- .002	D = W + 0.010"	0307 PDWC 03375 X XXXX
3.500	+ .002/- .000	3.249	+ .000/- .002	3.479	+ .000/- .002	D = W + 0.010"	0307 PDWC 03500 X XXXX
3.625	+ .002/- .000	3.374	+ .000/- .002	3.604	+ .000/- .002	D = W + 0.010"	0307 PDWC 03625 X XXXX
3.750	+ .002/- .000	3.499	+ .000/- .002	3.729	+ .000/- .002	D = W + 0.010"	0307 PDWC 03750 X XXXX
3.875	+ .002/- .000	3.624	+ .000/- .002	3.854	+ .000/- .002	D = W + 0.010"	0307 PDWC 03875 X XXXX
4.000	+ .002/- .000	3.749	+ .000/- .002	3.979	+ .000/- .002	D = W + 0.010"	0307 PDWC 04000 X XXXX
4.125	+ .002/- .000	3.874	+ .000/- .002	4.104	+ .000/- .002	D = W + 0.010"	0307 PDWC 04125 X XXXX
4.250	+ .002/- .000	3.999	+ .000/- .002	4.229	+ .000/- .002	D = W + 0.010"	0307 PDWC 04250 X XXXX
4.375	+ .002/- .000	4.124	+ .000/- .002	4.354	+ .000/- .002	D = W + 0.010"	0307 PDWC 04375 X XXXX
4.500	+ .002/- .000	4.249	+ .000/- .002	4.479	+ .000/- .002	D = W + 0.010"	0307 PDWC 04500 X XXXX
4.625	+ .002/- .000	4.374	+ .000/- .002	4.604	+ .000/- .002	D = W + 0.010"	0307 PDWC 04625 X XXXX
4.750	+ .002/- .000	4.499	+ .000/- .002	4.729	+ .000/- .002	D = W + 0.010"	0307 PDWC 04750 X XXXX
4.875	+ .002/- .000	4.624	+ .000/- .002	4.854	+ .000/- .002	D = W + 0.010"	0307 PDWC 04875 X XXXX
5.000	+ .002/- .000	4.749	+ .000/- .002	4.978	+ .000/- .002	D = W + 0.010"	0307 PDWC 05000 X XXXX
5.125	+ .002/- .000	4.874	+ .000/- .002	5.103	+ .000/- .002	D = W + 0.010"	0307 PDWC 05125 X XXXX
5.250	+ .004/- .000	4.999	+ .000/- .003	5.228	+ .000/- .003	D = W + 0.010"	0307 PDWC 05250 X XXXX
5.375	+ .004/- .000	5.124	+ .000/- .003	5.353	+ .000/- .003	D = W + 0.010"	0307 PDWC 05375 X XXXX
5.500	+ .004/- .000	5.249	+ .000/- .003	5.478	+ .000/- .003	D = W + 0.010"	0307 PDWC 05500 X XXXX
5.625	+ .004/- .000	5.374	+ .000/- .003	5.603	+ .000/- .003	D = W + 0.010"	0307 PDWC 05625 X XXXX
5.750	+ .004/- .000	5.499	+ .000/- .003	5.728	+ .000/- .003	D = W + 0.010"	0307 PDWC 05750 X XXXX
5.875	+ .004/- .000	5.624	+ .000/- .003	5.853	+ .000/- .003	D = W + 0.010"	0307 PDWC 05875 X XXXX
6.000	+ .004/- .000	5.749	+ .000/- .003	5.978	+ .000/- .003	D = W + 0.010"	0307 PDWC 06000 X XXXX
6.125	+ .004/- .000	5.874	+ .000/- .003	6.103	+ .000/- .003	D = W + 0.010"	0307 PDWC 06125 X XXXX
6.250	+ .004/- .000	5.999	+ .000/- .003	6.228	+ .000/- .003	D = W + 0.010"	0307 PDWC 06250 X XXXX
6.375	+ .004/- .000	6.124	+ .000/- .003	6.353	+ .000/- .003	D = W + 0.010"	0307 PDWC 06375 X XXXX
6.500	+ .004/- .000	6.249	+ .000/- .003	6.478	+ .000/- .003	D = W + 0.010"	0307 PDWC 06500 X XXXX
6.750	+ .004/- .000	6.499	+ .000/- .003	6.728	+ .000/- .003	D = W + 0.010"	0307 PDWC 06750 X XXXX



WEAR RINGS / BEARINGS

PDW Profile

GO TO CATALOG
Table of Contents

GLAND DIMENSIONS — PDW Profile, Piston — Inch (cont'd)

A Bore Diameter		B Groove Diameter		C Piston Diameter		D Groove Width	Part Number
Dia.	Tol.	Dia.	Tol.	Dia.	Tol.	+ .010 / -.000	PDWC
2.000	+ .004 / -.000	1.749	+ .000 / -.003	1.979	+ .000 / -.003	D = W + 0.010"	0307 PDWC 02000 X XXXX
2.125	+ .004 / -.000	1.874	+ .000 / -.003	2.104	+ .000 / -.003	D = W + 0.010"	0307 PDWC 02125 X XXXX
2.250	+ .004 / -.000	1.999	+ .000 / -.003	2.229	+ .000 / -.003	D = W + 0.010"	0307 PDWC 02250 X XXXX
2.375	+ .004 / -.000	2.124	+ .000 / -.003	2.354	+ .000 / -.003	D = W + 0.010"	0307 PDWC 02375 X XXXX
2.500	+ .004 / -.000	2.249	+ .000 / -.003	2.479	+ .000 / -.003	D = W + 0.010"	0307 PDWC 02500 X XXXX
2.625	+ .004 / -.000	2.374	+ .000 / -.003	2.604	+ .000 / -.003	D = W + 0.010"	0307 PDWC 02625 X XXXX
2.750	+ .004 / -.000	2.499	+ .000 / -.003	2.729	+ .000 / -.003	D = W + 0.010"	0307 PDWC 02750 X XXXX
2.875	+ .004 / -.000	2.624	+ .000 / -.003	2.854	+ .000 / -.003	D = W + 0.010"	0307 PDWC 02875 X XXXX
3.000	+ .004 / -.000	2.749	+ .000 / -.003	2.979	+ .000 / -.003	D = W + 0.010"	0307 PDWC 03000 X XXXX
3.125	+ .004 / -.000	2.874	+ .000 / -.003	3.104	+ .000 / -.003	D = W + 0.010"	0307 PDWC 03125 X XXXX
3.250	+ .004 / -.000	2.999	+ .000 / -.003	3.229	+ .000 / -.003	D = W + 0.010"	0307 PDWC 03250 X XXXX
3.375	+ .004 / -.000	3.124	+ .000 / -.003	3.354	+ .000 / -.003	D = W + 0.010"	0307 PDWC 03375 X XXXX
3.500	+ .004 / -.000	3.249	+ .000 / -.003	3.479	+ .000 / -.003	D = W + 0.010"	0307 PDWC 03500 X XXXX
3.625	+ .004 / -.000	3.374	+ .000 / -.003	3.604	+ .000 / -.003	D = W + 0.010"	0307 PDWC 03625 X XXXX
3.750	+ .004 / -.000	3.499	+ .000 / -.003	3.729	+ .000 / -.003	D = W + 0.010"	0307 PDWC 03750 X XXXX
3.875	+ .004 / -.000	3.624	+ .000 / -.003	3.854	+ .000 / -.003	D = W + 0.010"	0307 PDWC 03875 X XXXX
4.000	+ .004 / -.000	3.749	+ .000 / -.003	3.979	+ .000 / -.003	D = W + 0.010"	0307 PDWC 04000 X XXXX
4.125	+ .004 / -.000	3.874	+ .000 / -.003	4.104	+ .000 / -.003	D = W + 0.010"	0307 PDWC 04125 X XXXX
4.250	+ .004 / -.000	3.999	+ .000 / -.003	4.229	+ .000 / -.003	D = W + 0.010"	0307 PDWC 04250 X XXXX
4.375	+ .004 / -.000	4.124	+ .000 / -.003	4.354	+ .000 / -.003	D = W + 0.010"	0307 PDWC 04375 X XXXX
4.500	+ .004 / -.000	4.249	+ .000 / -.003	4.479	+ .000 / -.003	D = W + 0.010"	0307 PDWC 04500 X XXXX
4.625	+ .004 / -.000	4.374	+ .000 / -.003	4.604	+ .000 / -.003	D = W + 0.010"	0307 PDWC 04625 X XXXX
4.750		4.499		4.729	+ .000 / -.003	D = W + 0.010"	0307 PDWC 04750 X XXXX
4.875	+ .002 / -.000	4.624	+ .000 / -.002	4.854	+ .000 / -.002	D = W + 0.010"	0307 PDWC 04875 X XXXX
5.000	+ .002 / -.000	4.749	+ .000 / -.002	4.978	+ .000 / -.002	D = W + 0.010"	0307 PDWC 05000 X XXXX
5.125	+ .002 / -.000	4.874	+ .000 / -.002	5.103	+ .000 / -.002	D = W + 0.010"	0307 PDWC 05125 X XXXX
5.250	+ .004 / -.000	4.999	+ .000 / -.003	5.228	+ .000 / -.003	D = W + 0.010"	0307 PDWC 05250 X XXXX
5.375	+ .004 / -.000	5.124	+ .000 / -.003	5.353	+ .000 / -.003	D = W + 0.010"	0307 PDWC 05375 X XXXX
5.500	+ .004 / -.000	5.249	+ .000 / -.003	5.478	+ .000 / -.003	D = W + 0.010"	0307 PDWC 05500 X XXXX
5.625	+ .004 / -.000	5.374	+ .000 / -.003	5.603	+ .000 / -.003	D = W + 0.010"	0307 PDWC 05625 X XXXX
5.750	+ .004 / -.000	5.499	+ .000 / -.003	5.728	+ .000 / -.003	D = W + 0.010"	0307 PDWC 05750 X XXXX
5.875	+ .004 / -.000	5.624	+ .000 / -.003	5.853	+ .000 / -.003	D = W + 0.010"	0307 PDWC 05875 X XXXX
6.000	+ .004 / -.000	5.749	+ .000 / -.003	5.978	+ .000 / -.003	D = W + 0.010"	0307 PDWC 06000 X XXXX
6.125	+ .004 / -.000	5.874	+ .000 / -.003	6.103	+ .000 / -.003	D = W + 0.010"	0307 PDWC 06125 X XXXX
6.250	+ .004 / -.000	5.999	+ .000 / -.003	6.228	+ .000 / -.003	D = W + 0.010"	0307 PDWC 06250 X XXXX
6.375	+ .004 / -.000	6.124	+ .000 / -.003	6.353	+ .000 / -.003	D = W + 0.010"	0307 PDWC 06375 X XXXX
7.000	+ .004 / -.000	6.749	+ .000 / -.003	6.978	+ .000 / -.003	D = W + 0.010"	0307 PDWC 07000 X XXXX
7.250	+ .004 / -.000	6.999	+ .000 / -.003	7.228	+ .000 / -.003	D = W + 0.010"	0307 PDWC 07250 X XXXX
7.500	+ .004 / -.000	7.249	+ .000 / -.003	7.478	+ .000 / -.003	D = W + 0.010"	0307 PDWC 07500 X XXXX
7.750	+ .004 / -.000	7.499	+ .000 / -.003	7.728	+ .000 / -.003	D = W + 0.010"	0307 PDWC 07750 X XXXX
8.000	+ .004 / -.000	7.749	+ .000 / -.003	7.977	+ .000 / -.003	D = W + 0.010"	0307 PDWC 08000 X XXXX
8.250	+ .004 / -.000	7.999	+ .000 / -.003	8.227	+ .000 / -.003	D = W + 0.010"	0307 PDWC 08250 X XXXX
8.500	+ .004 / -.000	8.249	+ .000 / -.003	8.477	+ .000 / -.003	D = W + 0.010"	0307 PDWC 08500 X XXXX
9.000	+ .004 / -.000	8.749	+ .000 / -.003	8.977	+ .000 / -.003	D = W + 0.010"	0307 PDWC 09000 X XXXX
9.500	+ .004 / -.000	9.249	+ .000 / -.003	9.477	+ .000 / -.003	D = W + 0.010"	0307 PDWC 09500 X XXXX
10.000	+ .004 / -.000	9.749	+ .000 / -.003	9.977	+ .000 / -.003	D = W + 0.010"	0307 PDWC 10000 X XXXX
10.500	+ .004 / -.000	10.249	+ .000 / -.003	10.477	+ .000 / -.003	D = W + 0.010"	0307 PDWC 10500 X XXXX
11.000	+ .004 / -.000	10.749	+ .000 / -.003	10.977	+ .000 / -.003	D = W + 0.010"	0307 PDWC 11000 X XXXX
11.500	+ .004 / -.000	11.249	+ .000 / -.003	11.477	+ .000 / -.003	D = W + 0.010"	0307 PDWC 11500 X XXXX
12.000	+ .004 / -.000	11.749	+ .000 / -.003	11.977	+ .000 / -.003	D = W + 0.010"	0307 PDWC 12000 X XXXX
12.500	+ .004 / -.000	12.249	+ .000 / -.003	12.477	+ .000 / -.003	D = W + 0.010"	0307 PDWC 12500 X XXXX
13.000	+ .004 / -.000	12.749	+ .000 / -.003	12.977	+ .000 / -.003	D = W + 0.010"	0307 PDWC 13000 X XXXX
13.500	+ .004 / -.000	13.249	+ .000 / -.003	13.477	+ .000 / -.003	D = W + 0.010"	0307 PDWC 13500 X XXXX
14.000	+ .004 / -.000	13.749	+ .000 / -.003	13.977	+ .000 / -.003	D = W + 0.010"	0307 PDWC 14000 X XXXX
14.500	+ .004 / -.000	14.249	+ .000 / -.003	14.477	+ .000 / -.003	D = W + 0.010"	0307 PDWC 14500 X XXXX
15.000	+ .004 / -.000	14.749	+ .000 / -.003	14.977	+ .000 / -.003	D = W + 0.010"	0307 PDWC 15000 X XXXX
15.500	+ .004 / -.000	15.249	+ .000 / -.003	15.477	+ .000 / -.003	D = W + 0.010"	0307 PDWC 15500 X XXXX
16.000	+ .004 / -.000	15.749	+ .000 / -.003	15.977	+ .000 / -.003	D = W + 0.010"	0307 PDWC 16000 X XXXX



PDW Profile

GLAND DIMENSIONS — PDW Profile, Rod

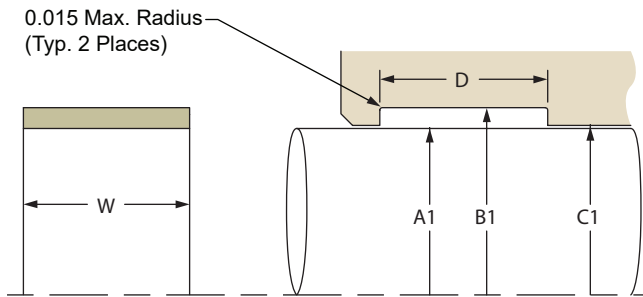

Please refer to the [Engineering Section](#) for surface finish and additional hardware considerations.

GLAND DIMENSIONS — PDW Profile, Rod — Inch

A Rod Diameter		B Groove Diameter		C Throat Diameter		D Groove Width	Part Number
Dia.	Tol.	Dia.	Tol.	Dia.	Tol.	+ .010 / - .000	PDWD
0.312	+ .000 / - .002	0.437	+ .002 / - .000	0.333	+ .002 / - .000	D = W + 0.010"	0307 PDWD 00875 X XXXX
0.375	+ .000 / - .002	0.500	+ .002 / - .000	0.396	+ .002 / - .000	D = W + 0.010"	0307 PDWD 00375 X XXXX
0.437	+ .000 / - .002	0.562	+ .002 / - .000	0.458	+ .002 / - .000	D = W + 0.010"	0307 PDWD 00437 X XXXX
0.500	+ .000 / - .002	0.625	+ .002 / - .000	0.521	+ .002 / - .000	D = W + 0.010"	0307 PDWD 00500 X XXXX
0.562	+ .000 / - .002	0.687	+ .002 / - .000	0.583	+ .002 / - .000	D = W + 0.010"	0307 PDWD 00562 X XXXX
0.625	+ .000 / - .002	0.750	+ .002 / - .000	0.646	+ .002 / - .000	D = W + 0.010"	0307 PDWD 00625 X XXXX
0.687	+ .000 / - .002	0.812	+ .002 / - .000	0.708	+ .002 / - .000	D = W + 0.010"	0307 PDWD 00687 X XXXX
0.750	+ .000 / - .002	0.875	+ .002 / - .000	0.771	+ .002 / - .000	D = W + 0.010"	0307 PDWD 00750 X XXXX
0.812	+ .000 / - .002	0.937	+ .002 / - .000	0.833	+ .002 / - .000	D = W + 0.010"	0307 PDWD 00812 X XXXX
0.875	+ .000 / - .002	1.000	+ .002 / - .000	0.896	+ .002 / - .000	D = W + 0.010"	0307 PDWD 00875 X XXXX
0.937	+ .000 / - .002	1.062	+ .002 / - .000	0.958	+ .002 / - .000	D = W + 0.010"	0307 PDWD 00937 X XXXX
1.000	+ .000 / - .002	1.125	+ .002 / - .000	1.021	+ .002 / - .000	D = W + 0.010"	0307 PDWD 01000 X XXXX
1.062	+ .000 / - .002	1.187	+ .002 / - .000	1.083	+ .002 / - .000	D = W + 0.010"	0307 PDWD 01062 X XXXX
1.125	+ .000 / - .002	1.250	+ .002 / - .000	1.146	+ .002 / - .000	D = W + 0.010"	0307 PDWD 01125 X XXXX
1.187	+ .000 / - .002	1.312	+ .002 / - .000	1.208	+ .002 / - .000	D = W + 0.010"	0307 PDWD 01187 X XXXX
1.250	+ .000 / - .002	1.375	+ .002 / - .000	1.271	+ .002 / - .000	D = W + 0.010"	0307 PDWD 01250 X XXXX
1.312	+ .000 / - .002	1.437	+ .002 / - .000	1.333	+ .002 / - .000	D = W + 0.010"	0307 PDWD 01312 X XXXX
1.375	+ .000 / - .002	1.500	+ .002 / - .000	1.396	+ .002 / - .000	D = W + 0.010"	0307 PDWD 01375 X XXXX
1.437	+ .000 / - .002	1.562	+ .002 / - .000	1.458	+ .002 / - .000	D = W + 0.010"	0307 PDWD 01437 X XXXX
1.500	+ .000 / - .002	1.625	+ .002 / - .000	1.521	+ .002 / - .000	D = W + 0.010"	0307 PDWD 01500 X XXXX
1.625	+ .000 / - .002	1.750	+ .002 / - .000	1.646	+ .002 / - .000	D = W + 0.010"	0307 PDWD 01625 X XXXX
1.750	+ .000 / - .002	1.875	+ .002 / - .000	1.771	+ .002 / - .000	D = W + 0.010"	0307 PDWD 01750 X XXXX
1.875	+ .000 / - .002	2.000	+ .002 / - .000	1.896	+ .002 / - .000	D = W + 0.010"	0307 PDWD 01875 X XXXX
2.000	+ .000 / - .002	2.125	+ .002 / - .000	2.021	+ .002 / - .000	D = W + 0.010"	0307 PDWD 02000 X XXXX



PDW Profile

GLAND DIMENSIONS — PDW Profile, Rod — Inch (cont'd)

A Rod Diameter		B Groove Diameter		C Throat Diameter		D Groove Width	Part Number
Dia.	Tol.	Dia.	Tol.	Dia.	Tol.	+ .010/- .000	PDWE
1.500	+ .000/- .002	1.687	+ .002/- .000	1.521	+ .002/- .000	D = W + 0.010"	0307 PDWE 01500 X XXXX
1.625	+ .000/- .002	1.812	+ .002/- .000	1.646	+ .002/- .000	D = W + 0.010"	0307 PDWE 01625 X XXXX
1.750	+ .000/- .002	1.937	+ .002/- .000	1.771	+ .002/- .000	D = W + 0.010"	0307 PDWE 01750 X XXXX
1.875	+ .000/- .002	2.062	+ .002/- .000	1.896	+ .002/- .000	D = W + 0.010"	0307 PDWE 01875 X XXXX
2.000	+ .000/- .002	2.187	+ .002/- .000	2.021	+ .002/- .000	D = W + 0.010"	0307 PDWE 02000 X XXXX
2.125	+ .000/- .002	2.312	+ .002/- .000	2.146	+ .002/- .000	D = W + 0.010"	0307 PDWE 02125 X XXXX
2.250	+ .000/- .002	2.437	+ .002/- .000	2.271	+ .002/- .000	D = W + 0.010"	0307 PDWE 02250 X XXXX
2.375	+ .000/- .002	2.562	+ .002/- .000	2.396	+ .002/- .000	D = W + 0.010"	0307 PDWE 02375 X XXXX
2.500	+ .000/- .002	2.687	+ .002/- .000	2.521	+ .002/- .000	D = W + 0.010"	0307 PDWE 02500 X XXXX
2.625	+ .000/- .002	2.812	+ .002/- .000	2.646	+ .002/- .000	D = W + 0.010"	0307 PDWE 02625 X XXXX
2.750	+ .000/- .002	2.937	+ .002/- .000	2.771	+ .002/- .000	D = W + 0.010"	0307 PDWE 02750 X XXXX
2.875	+ .000/- .002	3.062	+ .002/- .000	2.896	+ .002/- .000	D = W + 0.010"	0307 PDWE 02875 X XXXX
3.000	+ .000/- .002	3.187	+ .002/- .000	3.021	+ .002/- .000	D = W + 0.010"	0307 PDWE 03000 X XXXX
3.125	+ .000/- .002	3.312	+ .002/- .000	3.146	+ .002/- .000	D = W + 0.010"	0307 PDWE 03125 X XXXX
3.250	+ .000/- .002	3.437	+ .002/- .000	3.271	+ .002/- .000	D = W + 0.010"	0307 PDWE 03250 X XXXX
3.375	+ .000/- .002	3.562	+ .002/- .000	3.396	+ .002/- .000	D = W + 0.010"	0307 PDWE 03375 X XXXX
3.500	+ .000/- .002	3.687	+ .002/- .000	3.521	+ .002/- .000	D = W + 0.010"	0307 PDWE 03500 X XXXX
3.625	+ .000/- .002	3.812	+ .002/- .000	3.646	+ .002/- .000	D = W + 0.010"	0307 PDWE 03625 X XXXX
3.750	+ .000/- .002	3.937	+ .002/- .000	3.771	+ .002/- .000	D = W + 0.010"	0307 PDWE 03750 X XXXX
3.875	+ .000/- .002	4.062	+ .002/- .000	3.896	+ .002/- .000	D = W + 0.010"	0307 PDWE 03875 X XXXX
4.000	+ .000/- .002	4.187	+ .002/- .000	4.021	+ .002/- .000	D = W + 0.010"	0307 PDWE 04000 X XXXX
4.125	+ .000/- .002	4.312	+ .002/- .000	4.146	+ .002/- .000	D = W + 0.010"	0307 PDWE 04125 X XXXX
4.250	+ .000/- .002	4.437	+ .002/- .000	4.271	+ .002/- .000	D = W + 0.010"	0307 PDWE 04250 X XXXX
4.375	+ .000/- .002	4.562	+ .002/- .000	4.396	+ .002/- .000	D = W + 0.010"	0307 PDWE 04375 X XXXX
4.500	+ .000/- .002	4.687	+ .002/- .000	4.521	+ .002/- .000	D = W + 0.010"	0307 PDWE 04500 X XXXX
4.625	+ .000/- .002	4.812	+ .002/- .000	4.646	+ .002/- .000	D = W + 0.010"	0307 PDWE 04625 X XXXX
4.750	+ .000/- .002	4.937	+ .002/- .000	4.771	+ .002/- .000	D = W + 0.010"	0307 PDWE 04750 X XXXX
4.875	+ .000/- .002	5.062	+ .002/- .000	4.896	+ .002/- .000	D = W + 0.010"	0307 PDWE 04875 X XXXX
5.000	+ .000/- .002	5.187	+ .002/- .000	5.021	+ .002/- .000	D = W + 0.010"	0307 PDWE 05000 X XXXX

PDW Profile

GLAND DIMENSIONS – PDW Profile, Rod – Inch (cont'd)

A Rod Diameter		B Groove Diameter		C Throat Diameter		D Groove Width	Part Number
Dia.	Tol.	Dia.	Tol.	Dia.	Tol.	+ .010 / - .000	PDWF
1.500	+ .000 / - .002	1.751	+ .002 / - .000	1.521	+ .002 / - .000	D = W + 0.010"	0307 PDWF 01500 X XXXX
1.625	+ .000 / - .002	1.876	+ .002 / - .000	1.646	+ .002 / - .000	D = W + 0.010"	0307 PDWF 01625 X XXXX
1.750	+ .000 / - .002	2.001	+ .002 / - .000	1.771	+ .002 / - .000	D = W + 0.010"	0307 PDWF 01750 X XXXX
1.875	+ .000 / - .002	2.126	+ .002 / - .000	1.896	+ .002 / - .000	D = W + 0.010"	0307 PDWF 01875 X XXXX
2.000	+ .000 / - .002	2.251	+ .002 / - .000	2.021	+ .002 / - .000	D = W + 0.010"	0307 PDWF 02000 X XXXX
2.125	+ .000 / - .002	2.376	+ .002 / - .000	2.146	+ .002 / - .000	D = W + 0.010"	0307 PDWF 02125 X XXXX
2.250	+ .000 / - .002	2.501	+ .002 / - .000	2.271	+ .002 / - .000	D = W + 0.010"	0307 PDWF 02250 X XXXX
2.375	+ .000 / - .002	2.626	+ .002 / - .000	2.396	+ .002 / - .000	D = W + 0.010"	0307 PDWF 02375 X XXXX
2.500	+ .000 / - .002	2.751	+ .002 / - .000	2.521	+ .002 / - .000	D = W + 0.010"	0307 PDWF 02500 X XXXX
2.625	+ .000 / - .002	2.876	+ .002 / - .000	2.646	+ .002 / - .000	D = W + 0.010"	0307 PDWF 02625 X XXXX
2.750	+ .000 / - .002	3.001	+ .002 / - .000	2.771	+ .002 / - .000	D = W + 0.010"	0307 PDWF 02750 X XXXX
2.875	+ .000 / - .002	3.126	+ .002 / - .000	2.896	+ .002 / - .000	D = W + 0.010"	0307 PDWF 02875 X XXXX
3.000	+ .000 / - .002	3.251	+ .002 / - .000	3.021	+ .002 / - .000	D = W + 0.010"	0307 PDWF 03000 X XXXX
3.125	+ .000 / - .002	3.376	+ .002 / - .000	3.146	+ .002 / - .000	D = W + 0.010"	0307 PDWF 03125 X XXXX
3.250	+ .000 / - .002	3.501	+ .002 / - .000	3.271	+ .002 / - .000	D = W + 0.010"	0307 PDWF 03250 X XXXX
3.375	+ .000 / - .002	3.626	+ .002 / - .000	3.396	+ .002 / - .000	D = W + 0.010"	0307 PDWF 03375 X XXXX
3.500	+ .000 / - .002	3.751	+ .002 / - .000	3.521	+ .002 / - .000	D = W + 0.010"	0307 PDWF 03500 X XXXX
3.625	+ .000 / - .002	3.876	+ .002 / - .000	3.646	+ .002 / - .000	D = W + 0.010"	0307 PDWF 03625 X XXXX
3.750	+ .000 / - .002	4.001	+ .002 / - .000	3.771	+ .002 / - .000	D = W + 0.010"	0307 PDWF 03750 X XXXX
3.875	+ .000 / - .002	4.126	+ .002 / - .000	3.896	+ .002 / - .000	D = W + 0.010"	0307 PDWF 03875 X XXXX
4.000	+ .000 / - .002	4.251	+ .002 / - .000	4.021	+ .002 / - .000	D = W + 0.010"	0307 PDWF 04000 X XXXX
4.125	+ .000 / - .002	4.376	+ .002 / - .000	4.146	+ .002 / - .000	D = W + 0.010"	0307 PDWF 04125 X XXXX
4.250	+ .000 / - .002	4.501	+ .002 / - .000	4.271	+ .002 / - .000	D = W + 0.010"	0307 PDWF 04250 X XXXX
4.375	+ .000 / - .002	4.626	+ .002 / - .000	4.396	+ .002 / - .000	D = W + 0.010"	0307 PDWF 04375 X XXXX
4.500	+ .000 / - .002	4.751	+ .002 / - .000	4.521	+ .002 / - .000	D = W + 0.010"	0307 PDWF 04500 X XXXX
4.625	+ .000 / - .002	4.876	+ .002 / - .000	4.646	+ .002 / - .000	D = W + 0.010"	0307 PDWF 04625 X XXXX
4.750	+ .000 / - .004	5.001	+ .003 / - .000	4.772	+ .003 / - .000	D = W + 0.010"	0307 PDWF 04750 X XXXX
4.875	+ .000 / - .004	5.126	+ .003 / - .000	4.897	+ .003 / - .000	D = W + 0.010"	0307 PDWF 04875 X XXXX
5.000	+ .000 / - .004	5.251	+ .003 / - .000	5.022	+ .003 / - .000	D = W + 0.010"	0307 PDWF 05000 X XXXX
5.125	+ .000 / - .004	5.376	+ .003 / - .000	5.147	+ .003 / - .000	D = W + 0.010"	0307 PDWF 05125 X XXXX
5.250	+ .000 / - .004	5.501	+ .003 / - .000	5.272	+ .003 / - .000	D = W + 0.010"	0307 PDWF 05250 X XXXX
5.375	+ .000 / - .004	5.626	+ .003 / - .000	5.397	+ .003 / - .000	D = W + 0.010"	0307 PDWF 05375 X XXXX
5.500	+ .000 / - .004	5.751	+ .003 / - .000	5.522	+ .003 / - .000	D = W + 0.010"	0307 PDWF 05500 X XXXX
5.625	+ .000 / - .004	5.876	+ .003 / - .000	5.647	+ .003 / - .000	D = W + 0.010"	0307 PDWF 05625 X XXXX
5.750	+ .000 / - .004	6.001	+ .003 / - .000	5.772	+ .003 / - .000	D = W + 0.010"	0307 PDWF 05750 X XXXX
5.875	+ .000 / - .004	6.126	+ .003 / - .000	5.897	+ .003 / - .000	D = W + 0.010"	0307 PDWF 05875 X XXXX
6.000	+ .000 / - .004	6.251	+ .003 / - .000	6.022	+ .003 / - .000	D = W + 0.010"	0307 PDWF 06000 X XXXX
6.250	+ .000 / - .004	6.501	+ .003 / - .000	6.272	+ .003 / - .000	D = W + 0.010"	0307 PDWF 06250 X XXXX
6.500	+ .000 / - .004	6.751	+ .003 / - .000	6.522	+ .003 / - .000	D = W + 0.010"	0307 PDWF 06500 X XXXX
6.750	+ .000 / - .004	7.001	+ .003 / - .000	6.772	+ .003 / - .000	D = W + 0.010"	0307 PDWF 06750 X XXXX
7.000	+ .000 / - .004	7.251	+ .003 / - .000	7.022	+ .003 / - .000	D = W + 0.010"	0307 PDWF 07000 X XXXX
7.250	+ .000 / - .004	7.501	+ .003 / - .000	7.272	+ .003 / - .000	D = W + 0.010"	0307 PDWF 07250 X XXXX
7.500	+ .000 / - .004	7.751	+ .003 / - .000	7.522	+ .003 / - .000	D = W + 0.010"	0307 PDWF 07500 X XXXX



PDW Profile

GLAND DIMENSIONS — PDW Profile, Rod — Inch (cont'd)

A Rod Diameter		B Groove Diameter		C Throat Diameter		D Groove Width	Part Number
Dia.	Tol.	Dia.	Tol.	Dia.	Tol.	+.010/-0.000	PDWF
5.125	+0.000/-0.004	5.376	+0.003/-0.000	5.147	+0.003/-0.000	D = W + 0.010"	0307 PDWF 05125 X XXXX
5.250	+0.000/-0.004	5.501	+0.003/-0.000	5.272	+0.003/-0.000	D = W + 0.010"	0307 PDWF 05250 X XXXX
5.375	+0.000/-0.004	5.626	+0.003/-0.000	5.397	+0.003/-0.000	D = W + 0.010"	0307 PDWF 05375 X XXXX
5.500	+0.000/-0.004	5.751	+0.003/-0.000	5.522	+0.003/-0.000	D = W + 0.010"	0307 PDWF 05500 X XXXX
5.625	+0.000/-0.004	5.876	+0.003/-0.000	5.647	+0.003/-0.000	D = W + 0.010"	0307 PDWF 05625 X XXXX
5.750	+0.000/-0.004	6.001	+0.003/-0.000	5.772	+0.003/-0.000	D = W + 0.010"	0307 PDWF 05750 X XXXX
5.875	+0.000/-0.004	6.126	+0.003/-0.000	5.897	+0.003/-0.000	D = W + 0.010"	0307 PDWF 05875 X XXXX
6.000	+0.000/-0.004	6.251	+0.003/-0.000	6.022	+0.003/-0.000	D = W + 0.010"	0307 PDWF 06000 X XXXX
6.250	+0.000/-0.004	6.501	+0.003/-0.000	6.272	+0.003/-0.000	D = W + 0.010"	0307 PDWF 06250 X XXXX
6.500	+0.000/-0.004	6.751	+0.003/-0.000	6.522	+0.003/-0.000	D = W + 0.010"	0307 PDWF 06500 X XXXX
6.750	+0.000/-0.004	7.001	+0.003/-0.000	6.772	+0.003/-0.000	D = W + 0.010"	0307 PDWF 06750 X XXXX
7.000	+0.000/-0.004	7.251	+0.003/-0.000	7.022	+0.003/-0.000	D = W + 0.010"	0307 PDWF 07000 X XXXX
7.250	+0.000/-0.004	7.501	+0.003/-0.000	7.272	+0.003/-0.000	D = W + 0.010"	0307 PDWF 07250 X XXXX
7.500	+0.000/-0.004	7.751	+0.003/-0.000	7.522	+0.003/-0.000	D = W + 0.010"	0307 PDWF 07500 X XXXX



Parker proprietary Resilon® 4300 and Resilon® 4301 materials have unique advantages in comparison to materials for fluid power applications. The physical characteristics and mechanical properties of these polyurethane-based compounds deliver performance advantages over traditional elastomers with low compression set and excellent extrusion resistance.



POLYURETHANE O-RINGS

Parker polyurethane O-rings offer the material advantages exclusive to the Resilon® family of compounds in standard and custom O-ring sizes. High temperature Resilon® O-rings eliminate the need for back-ups, simplifying installation and reducing damage due to spiral failure.

POLYURETHANE D-RINGS

Parker's Resilon® polyurethane D-ring is a one-piece hydraulic valve sealing solution which delivers longer life and reduced warranty costs over traditional multiple-component seals.

POLYURETHANE PROFILES

Profile	Cross Section	Description	Standard Material	Page
			4300	
568		Rugged Resilon® polyurethane O-ring that fits standard dynamic and static industrial O-ring grooves	•	94
DG		One piece, easy-to-install, D-ring for hydraulic valves	•	104

568 Profile, Resilon® O-ring

Parker's 568 Profile, Resilon® O-ring delivers longer life and increased performance over traditional rubber O-rings. Superior mechanical and physical properties of Resilon® 4300 polyurethane deliver performance benefits that include:

- Advanced polyurethane compression set resistance and resilience
- Unmatched polyurethane high temperature capability and wear resistance
- Superior extrusion resistance which eliminates need for back-ups — easing installation and minimizing damage during installation
- Greater resistance to spiral failure
- Compound Resilon® 4301 offers excellent compatibility in water based fluids.

568 Profile Resilon® polyurethane O-rings match the diameter and cross section of AS568B O-rings and are used in the same grooves.

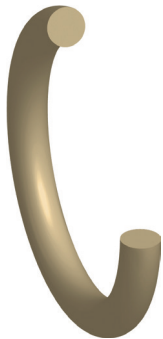

RANGE OF APPLICATION

Standard Material	Temperature	Pressure	Speed
P4300A90	-65°F to +275°F (-54°C to +135°C)	5000 psi (344 bar)	< 1.6 ft/s (0.5 m/s)
Additional Material			
P4301A90	-35°F to +225°F (-37°C to +107°C)	5000 psi (344 bar)	< 1.6 ft/s (0.5 m/s)

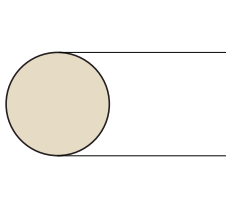

568 Cross Section

- Premium Resilon® material
- Compression set resistant
- Wear-resistant, extrusion resistant
- Eliminates need for back-ups
- Easy, damage-free installation
- Resists spiral failure
- Diameter and cross section match AS568B grooves

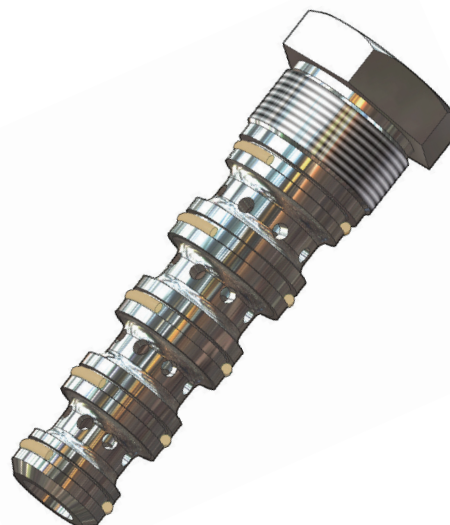

568 installed on Cartridge Valve



568 Profile

PART NUMBER NOMENCLATURE

568 Profile – Inch

4 3 0 0	568	2 - 1 2 8
4 Digit Material Code Example: 4300 = Resilon® 4300	Profile	AS568 O-ring Dash Number Example: 2-128 = 1.487" I.D. x 0.103" CS

GLAND DIMENSIONS – 568 Profile – Dynamic

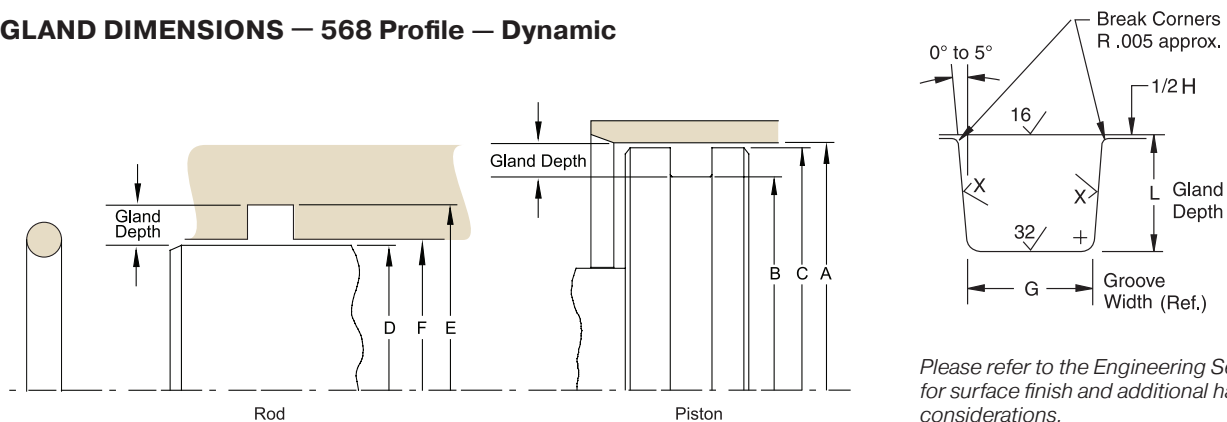

Please refer to the Engineering Section for surface finish and additional hardware considerations.

DIMENSIONAL DATA – Dynamic O-ring – Inch

O-ring 2-Size AS568A	Cross Section		Dynamic			H Diametral Clearance (a)	G-Groove Width			R Groove Radius	Max. Eccentricity (b)
	Nominal	Actual	L Gland Depth	Squeeze			0 Back-up Ring	1 Back-up Ring	2 Back-up Ring		
				Actual	%						
006 through 012	1/16	.070 ±.003	.055 to .057	.010 to .018	15 to 25	.002 to .005	.093 to .098	.138 to .143	.205 to .210	.005 to .015	.002
104 through 116	3/32	.103 ±.003	.088 to .090	.01 to .018	10 to 17	.002 to .005	.140 to .145	.171 to .176	.238 to .243	.005 to .015	.002
201 through 222	1/8	.139 ±.004	.121 to .123	.012 to .022	9 to 16	.003 to .006	.187 to .192	.208 to .213	.275 to .280	.010 to .025	.003
309 through 349	3/16	.210 ±.005	.185 to .188	.017 to .030	8 to 14	.003 to .006	.281 to .286	.311 to .316	.410 to .415	.020 to .035	.004
425 through 460	1/4	.275 ±.006	.237 to .240	.029 to .044	11 to 16	.004 to .007	.375 to .380	.408 to .413	.538 to .543	.020 to .035	.005

(a) Clearance (extrusion gap) must be held to a minimum consistent with design requirements for temperature range variation.

(b) Total indicator reading between groove and adjacent bearing surface.

NOTE: For sizes larger than those shown in the table, please contact your local Parker seal representative.



568 Profile

GLAND DIMENSIONS — Dynamic O-ring — Inch

O-ring 2-Size AS568	Seal Dimensions					Hardware Dimensions						Part Number
	Inside Dia.	±	Width	±	Mean O.D. (Ref)	Piston			Rod			
						A Bore Dia.	B Groove Dia.	C Piston Dia.	D Rod Dia.	E Groove Dia.	F Throat Dia.	
						+ .002/- .000	+ .000/- .002	+ .000/- .001	+ .000/- .002	+ .002/- .000	+ .001/- .000	
010	0.239	0.005	0.070	0.003	0.379	0.374	0.264	0.372	0.249	0.359	0.251	43005682-010
011	0.301	0.005	0.070	0.003	0.441	0.436	0.326	0.434	0.311	0.421	0.313	43005682-011
012	0.364	0.005	0.070	0.003	0.504	0.499	0.389	0.497	0.374	0.484	0.376	43005682-012
107	0.206	0.005	0.103	0.003	0.412	0.406	0.230	0.404	0.218	0.394	0.220	43005682-107
109	0.299	0.005	0.103	0.003	0.505	0.499	0.323	0.497	0.311	0.487	0.313	43005682-109
110	0.362	0.005	0.103	0.003	0.568	0.562	0.386	0.560	0.374	0.550	0.376	43005682-110
111	0.424	0.005	0.103	0.003	0.630	0.624	0.448	0.622	0.436	0.612	0.438	43005682-111
112	0.487	0.005	0.103	0.003	0.693	0.687	0.511	0.685	0.499	0.675	0.501	43005682-112
113	0.549	0.007	0.103	0.003	0.755	0.749	0.573	0.747	0.561	0.737	0.563	43005682-113
114	0.612	0.009	0.103	0.003	0.818	0.812	0.636	0.810	0.624	0.800	0.626	43005682-114
115	0.674	0.009	0.103	0.003	0.880	0.874	0.698	0.872	0.686	0.862	0.688	43005682-115
116	0.737	0.009	0.103	0.003	0.943	0.937	0.761	0.935	0.749	0.925	0.751	43005682-116
203	0.296	0.005	0.103	0.004	0.574	0.562	0.320	0.559	0.310	0.552	0.313	43005682-203
206	0.484	0.005	0.103	0.004	0.762	0.750	0.508	0.747	0.498	0.740	0.501	43005682-206
208	0.609	0.009	0.103	0.004	0.887	0.875	0.633	0.872	0.623	0.865	0.626	43005682-208
210	0.734	0.010	0.103	0.004	1.012	1.000	0.758	0.997	0.748	0.990	0.751	43005682-210
211	0.796	0.010	0.139	0.004	1.074	1.062	0.820	1.059	0.810	1.052	0.813	43005682-211
212	0.859	0.010	0.139	0.004	1.137	1.125	0.883	1.122	0.873	1.115	0.876	43005682-212
214	0.984	0.010	0.139	0.004	1.262	1.250	1.008	1.247	0.998	1.240	1.001	43005682-214
215	1.046	0.010	0.139	0.004	1.324	1.312	1.070	1.309	1.060	1.302	1.063	43005682-215
216	1.109	0.012	0.139	0.004	1.387	1.375	1.133	1.372	1.123	1.365	1.126	43005682-216
217	1.171	0.012	0.139	0.004	1.449	1.437	1.195	1.434	1.185	1.427	1.188	43005682-217
218	1.234	0.012	0.139	0.004	1.512	1.500	1.258	1.497	1.248	1.490	1.251	43005682-218
219	1.296	0.012	0.139	0.004	1.574	1.562	1.320	1.559	1.310	1.552	1.313	43005682-219

Piston O.D.s shown in the darker-shaded areas may over stretch the O-ring. If so, select a material with greater elongation or use a two-piece piston.

NOTE: For sizes larger than those shown in the table, please contact your local Parker seal representative.



568 Profile

GLAND DIMENSIONS — Dynamic O-ring — Inch (cont'd)

O-ring 2-Size AS568	Seal Dimensions					Hardware Dimensions						Part Number
	Inside Dia.	±	Width	±	Mean O.D. (Ref)	Piston			Rod			
						A Bore Dia.	B Groove Dia.	C Piston Dia.	D Rod Dia.	E Groove Dia.	F Throat Dia.	
						+ .002 / - .000	+ .000 / - .002	+ .000 / - .001	+ .000 / - .002	+ .002 / - .000	+ .001 / - .000	
220	1.359	0.012	0.139	0.004	1.637	1.625	1.383	1.622	1.373	1.615	1.376	43005682-220
221	1.421	0.012	0.139	0.004	1.699	1.687	1.445	1.684	1.435	1.677	1.438	43005682-221
222	1.484	0.015	0.139	0.004	1.762 1.27	1.750	1.508	1.747	1.498	1.740	1.501	43005682-222
316	0.850	0.010	0.210	0.005	1.270	1.250	0.880	1.247	0.873	1.243	0.876	43005682-316
321	1.162	0.012	0.210	0.005	1.582	1.562	1.192	1.559	1.185	1.555	1.188	43005682-321
323	1.287	0.012	0.210	0.005	1.707	1.687	1.317	1.684	1.310	1.680	1.313	43005682-323
324	1.350	0.012	0.210	0.005	1.770	1.750	1.380	1.747	1.373	1.743	1.376	43005682-324
325	1.475	0.015	0.210	0.005	1.895	1.875	1.505	1.872	1.498	1.868	1.501	43005682-325
326	1.600	0.015	0.210	0.005	2.020	2.000	1.630	1.997	1.623	1.993	1.626	43005682-326
327	1.725	0.015	0.210	0.005	2.145	2.125	1.755	2.122	1.748	2.118	1.751	43005682-327
328	1.850	0.015	0.210	0.005	2.270	2.250	1.880	2.247	1.873	2.243	1.876	43005682-328
329	1.975	0.018	0.210	0.005	2.395	2.375	2.005	2.372	1.998	2.368	2.001	43005682-329
337	2.975	0.024	0.210	0.005	3.395	2.375	3.005	3.372	2.998	3.368	3.001	43005682-337
425	4.475	0.033	0.275	0.006	5.025	5.002	4.528	4.998	4.497	4.971	4.501	43005682-425

Piston O.D.s shown in the darker-shaded areas may over stretch the O-ring. If so, select a material with greater elongation or use a two-piece piston.

NOTE: For sizes larger than those shown in the table, please contact your local Parker seal representative.



568 Profile

GLAND DIMENSIONS — 568 Profile — Static

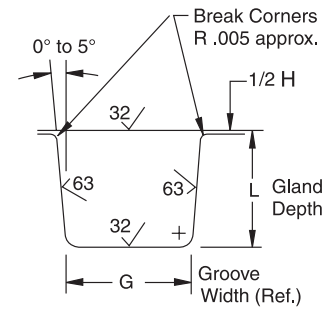
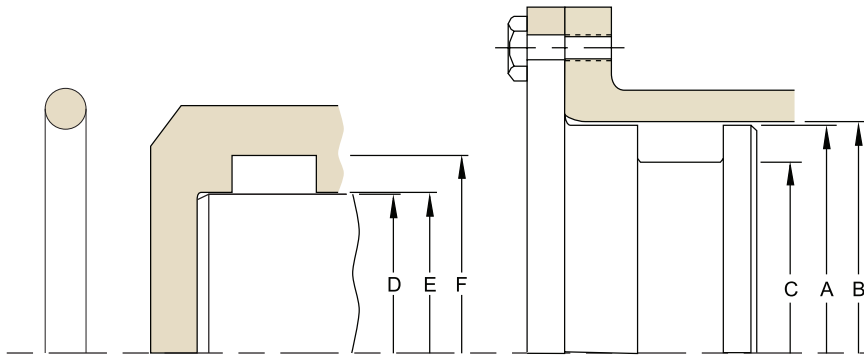

Please refer to the [Engineering Section](#) for surface finish and additional hardware considerations.

DIMENSIONAL DATA — Static O-ring — Inch

O-ring 2-Size AS568	Cross Section		Static			H Diametral Clearance (a)	G-Groove Width			R Groove Radius	Max. Eccentricity (b)
	Nominal	Actual	L Gland Depth	Squeeze			0 Back-up Ring	1 Back-up Ring	2 Back-up Ring		
				Actual	%						
004 through 050	1/16	0.070 ±0.003	0.050 to 0.052	0.015 to 0.023	22 to 32	0.002 to 0.005	0.093 to 0.098	0.138 to 0.143	0.205 to 0.210	0.005 to 0.015	0.002
102 through 178	3/32	.103 ±0.003	0.081 to 0.083	0.017 to 0.025	17 to 24	0.002 to 0.005	0.140 to 0.145	0.171 to 0.176	0.238 to 0.243	0.005 to 0.015	0.002
201 through 284	1/8	.139 ±0.004	0.111 to 0.113	0.022 to 0.032	16 to 23	0.003 to 0.006	0.187 to 0.192	0.208 to 0.213	0.275 to 0.280	0.010 to 0.025	0.003
309 through 395	3/16	.210 ±0.005	0.170 to 0.173	0.032 to 0.045	15 to 21	0.003 to 0.006	0.281 to 0.286	0.311 to 0.316	0.410 to 0.415	0.020 to 0.035	0.004
425 through 475	1/4	.275 ±0.006	0.226 to 0.229	0.040 to 0.055	15 to 20	0.004 to 0.007	0.375 to 0.380	0.408 to 0.413	0.538 to 0.543	0.020 to 0.035	0.005

(a) Clearance (extrusion gap) must be held to a minimum consistent with design requirements for temperature range variation.

(b) Total indicator reading between groove and adjacent bearing surface.

NOTE: For sizes larger than those shown in the table, please contact your local Parker seal representative.

568 Profile

GLAND DIMENSIONS — 568 Static O-ring — Inch

O-ring 2-Size AS568	Seal Dimensions					Piston						Part Number
	Inside Dia.	±	Width	±	Mean O.D. (Ref)	Piston			Rod			
						A Piston Dia.	B Bore Dia.	C Groove Dia.	D Rod Dia.	E Throat Dia.	F Groove Dia.	
						0	0	+ .000/- .002	+ .000/- .002	+ .001/- .000	+ .002/- .000	
010	0.239	0.005	0.070	0.003	0.379	0.373	0.375	0.275	0.250	0.252	0.350	43005682-010
011	0.301	0.005	0.070	0.003	0.441	0.435	0.437	0.337	0.312	0.314	0.412	43005682-011
012	0.364	0.005	0.070	0.003	0.504	0.498	0.500	0.400	0.375	0.377	0.475	43005682-012
013	0.426	0.005	0.070	0.003	0.566	0.560	0.562	0.462	0.437	0.439	0.537	43005682-013
014	0.489	0.005	0.070	0.003	0.629	0.623	0.625	0.525	0.500	0.502	0.600	43005682-014
015	0.551	0.007	0.070	0.003	0.691	0.685	0.687	0.587	0.562	0.564	0.662	43005682-015
016	0.614	0.009	0.070	0.003	0.754	0.748	0.750	0.650	0.625	0.627	0.725	43005682-016
017	0.676	0.009	0.070	0.003	0.816	0.810	0.812	0.712	0.687	0.689	0.787	43005682-017
018	0.739	0.009	0.070	0.003	0.879	0.873	0.875	0.775	0.750	0.752	0.850	43005682-018
019	0.801	0.009	0.070	0.003	0.941	0.935	0.937	0.837	0.812	0.812	0.912	43005682-019
020	0.864	0.009	0.070	0.003	1.004	0.998	1.000	0.900	0.875	0.877	0.975	43005682-020
021	0.926	0.009	0.070	0.003	1.066	1.060	1.062	0.962	0.937	0.939	1.037	43005682-021
022	0.989	0.010	0.070	0.003	1.129	1.123	1.125	1.025	1.000	1.002	1.100	43005682-022
023	1.051	0.010	0.070	0.003	1.191	1.185	1.187	1.087	1.062	1.064	1.162	43005682-023
024	1.114	0.010	0.070	0.003	1.254	1.248	1.250	1.150	1.125	1.127	1.225	43005682-024
025	1.176	0.011	0.070	0.003	1.316	1.310	1.312	1.212	1.187	1.189	1.287	43005682-025
026	1.239	0.011	0.070	0.003	1.379	1.373	1.375	1.275	1.250	1.252	1.350	43005682-026
027	1.301	0.011	0.070	0.003	1.441	1.435	1.437	1.337	1.312	1.314	1.412	43005682-027
028	1.364	0.013	0.070	0.003	1.504	1.498	1.500	1.400	1.375	1.377	1.475	43005682-028
030	1.614	0.013	0.070	0.003	1.754	1.748	1.750	1.650	1.625	1.627	1.725	43005682-030
031	1.739	0.015	0.070	0.003	1.879	1.873	1.875	1.775	1.750	1.752	1.850	43005682-031
032	1.864	0.015	0.070	0.003	2.004	1.998	2.000	1.900	1.875	1.877	1.975	43005682-032

Piston O.D.s shown in the darker-shaded areas may over stretch the O-ring. If so, select a material with greater elongation or use a two-piece piston.



568 Profile

GLAND DIMENSIONS — 568 Static O-ring — Inch (Cont'd)

O-ring 2-Size AS568	Seal Dimensions					Piston						Part Number
	Inside Dia.	±	Width	±	Mean O.D. (Ref)	Piston			Rod			
						A Piston Dia.	B Bore Dia.	C Groove Dia.	D Rod Dia.	E Throat Dia.	F Groove Dia.	
040	2.864	0.020	0.070	0.003	3.004	2.998	3.000	2.900	2.875	2.877	2.975	43005682-040
105	0.143	0.005	0.103	0.003	0.349	0.340	0.342	0.180	0.156	0.158	0.318	43005682-105
107	0.206	0.005	0.103	0.003	0.412	0.403	0.405	0.243	0.219	0.221	0.381	43005682-107
109	0.299	0.005	0.103	0.003	0.505	0.498	0.500	0.338	0.312	0.314	0.474	43005682-109
110	0.362	0.005	0.103	0.003	0.568	0.560	0.562	0.400	0.375	0.377	0.537	43005682-110
111	0.424	0.005	0.103	0.003	0.630	0.623	0.625	0.463	0.437	0.439	0.599	43005682-111
112	0.487	0.005	0.103	0.003	0.693	0.685	0.687	0.525	0.500	0.502	0.662	43005682-112
113	0.549	0.007	0.103	0.003	0.755	0.748	0.750	0.588	0.562	0.564	0.724	43005682-113
114	0.612	0.009	0.103	0.003	0.818	0.810	0.812	0.650	0.625	0.627	0.787	43005682-114
115	0.674	0.009	0.103	0.003	0.880	0.873	0.875	0.713	0.687	0.689	0.849	43005682-115
116	0.737	0.009	0.103	0.003	0.943	0.935	0.937	0.775	0.750	0.752	0.912	43005682-116
117	0.799	0.010	0.103	0.003	1.005	.998	1.000	0.838	0.812	0.814	0.974	43005682-117
118	0.862	0.010	0.103	0.003	1.068	1.060	1.062	0.900	0.875	0.877	1.037	43005682-118
119	0.924	0.010	0.103	0.003	1.130	1.123	1.125	0.963	0.937	0.939	1.099	43005682-119
120	0.987	0.010	0.103	0.003	1.193	1.185	1.187	1.025	1.000	1.002	1.162	43005682-120
121	1.049	0.010	0.103	0.003	1.255	1.248	1.250	1.088	1.062	1.064	1.224	43005682-121
122	1.112	0.010	0.103	0.003	1.318	1.310	1.312	1.150	1.125	1.127	1.287	43005682-122
123	1.174	0.012	0.103	0.003	1.380	1.373	1.375	1.213	1.187	1.189	1.349	43005682-123
124	1.237	0.012	0.103	0.003	1.443	1.435	1.437	1.275	1.250	1.252	1.412	43005682-124
125	1.299	0.012	0.103	0.003	1.505	1.498	1.500	1.338	1.312	1.314	1.474	43005682-125
127	1.424	0.012	0.103	0.003	1.630	1.623	1.625	1.463	1.437	1.439	1.599	43005682-127
128	1.487	0.012	0.103	0.003	1.693	1.685	1.687	1.525	1.500	1.502	1.662	43005682-128
129	1.549	0.015	0.103	0.003	1.755	1.748	1.750	1.588	1.562	1.564	1.724	43005682-129
130	1.612	0.015	0.103	0.003	1.818	1.810	1.812	1.650	1.625	1.627	1.787	43005682-130
131	1.674	0.015	0.103	0.003	1.880	1.873	1.875	1.713	1.687	1.689	1.849	43005682-131
132	1.737	0.015	0.103	0.003	1.943	1.935	1.937	1.775	1.750	1.752	1.912	43005682-132
133	1.799	0.015	0.103	0.003	2.005	1.998	2.000	1.838	1.812	1.814	1.974	43005682-133
134	1.862	0.015	0.103	0.003	2.068	2.060	2.062	1.900	1.875	1.877	2.037	43005682-134

Piston O.D.s shown in the darker-shaded areas may over stretch the O-ring. If so, select a material with greater elongation or use a two-piece piston.



568 Profile

GLAND DIMENSIONS — 568 Static O-ring — Inch (Cont'd)

O-ring 2-Size AS568	Seal Dimensions					Piston / Rod						Part Number
	Inside Dia.	±	Width	±	Mean O.D. (Ref)	Piston			Rod			
						A Piston Dia.	B Bore Dia.	C Groove Dia.	D Rod Dia.	E Throat Dia.	F Groove Dia.	
						+ .000 / - .001	+ .002 / - .000	+ .000 / - .002	+ .000 / - .002	+ .001 / - .000	+ .002 / - .000	
135	1.925	0.017	0.103	0.003	2.131	2.123	2.125	1.963	1.997	1.939	2.099	43005682-135
136	1.987	0.017	0.103	0.003	2.193	2.185	2.187	2.025	2.000	2.002	2.162	43005682-136
137	2.050	0.017	0.103	0.003	2.256	2.248	2.250	2.088	2.062	2.064	2.224	43005682-137
139	2.175	0.017	0.103	0.003	2.381	2.373	2.375	2.213	2.187	2.189	2.349	43005682-139
140	2.237	0.017	0.103	0.003	2.443	2.435	2.437	2.275	2.250	2.252	2.412	43005682-140
142	2.362	0.020	0.103	0.003	2.568	2.560	2.562	2.400	2.375	2.377	2.537	43005682-142
143	2.425	0.020	0.103	0.003	2.631	2.623	2.625	2.463	2.437	2.439	2.599	43005682-143
144	2.487	0.020	0.103	0.003	2.693	2.685	2.687	2.525	2.500	2.502	2.662	43005682-144
147	2.675	0.022	0.103	0.003	2.881	2.873	2.875	2.713	2.687	2.689	2.849	43005682-147
148	2.737	0.022	0.103	0.003	2.943	2.935	2.937	2.775	2.750	2.752	2.912	43005682-148
150	2.862	0.022	0.103	0.003	3.068	3.060	3.062	2.900	2.875	2.877	3.037	43005682-150
151	2.987	0.024	0.103	0.003	3.193	3.185	3.187	3.025	3.000	3.002	3.162	43005682-151
152	3.237	0.024	0.103	0.003	3.443	3.435	3.437	3.275	3.250	3.252	3.412	43005682-152
153	3.487	0.024	0.103	0.003	3.693	3.685	3.687	3.525	3.500	3.502	3.662	43005682-153
154	3.737	0.028	0.103	0.003	3.943	3.935	3.937	3.775	3.750	3.752	3.912	43005682-154
155	3.987	0.028	0.103	0.003	4.193	4.185	4.187	4.025	4.000	4.002	4.162	43005682-155
156	4.237	0.030	0.103	0.003	4.443	4.435	4.437	4.275	4.250	4.252	4.412	43005682-156
203	0.296	0.005	0.139	0.004	0.574	0.559	0.562	0.340	0.312	0.315	0.534	43005682-203
206	0.484	0.005	0.139	0.004	0.762	0.747	0.750	0.528	0.500	0.503	0.722	43005682-206
208	0.609	0.009	0.139	0.004	0.887	0.872	0.875	0.653	0.625	0.628	0.847	43005682-208
210	0.734	0.010	0.139	0.004	1.012	0.997	1.000	0.778	0.750	0.753	0.972	43005682-210
211	0.796	0.010	0.139	0.004	1.074	1.059	1.062	0.840	0.812	0.815	1.034	43005682-211
212	0.859	0.010	0.139	0.004	1.137	1.122	1.125	0.903	0.875	0.878	1.097	43005682-212
214	0.984	0.010	0.139	0.004	1.262	1.247	1.250	1.028	1.000	1.003	1.222	43005682-214
215	1.046	0.010	0.139	0.004	1.324	1.309	1.312	1.090	1.062	1.065	1.284	43005682-215
216	1.109	0.012	0.139	0.004	1.387	1.372	1.375	1.153	1.125	1.128	1.347	43005682-216
217	1.171	0.012	0.139	0.004	1.449	1.434	1.437	1.215	1.187	1.190	1.409	43005682-217
218	1.234	0.012	0.139	0.004	1.512	1.497	1.500	1.278	1.250	1.253	1.472	43005682-218

Piston O.D.s shown in the darker-shaded areas may over stretch the O-ring. If so, select a material with greater elongation or use a two-piece piston.



568 Profile

GLAND DIMENSIONS — 568 Static O-ring — Inch (Cont'd)

O-ring 2-Size AS568	Seal Dimensions					Piston						Part Number
	Inside Dia.	±	Width	±	Mean O.D. (Ref)	Piston			Rod			
						A Piston Dia.	B Bore Dia.	C Groove Dia.	D Rod Dia.	E Throat Dia.	F Groove Dia.	
219	1.296	0.012	0.139	0.004	1.574	1.559	1.562	1.340	1.312	1.315	1.534	43005682-219
220	1.359	0.012	0.139	0.004	1.637	1.622	1.625	1.403	1.375	1.378	1.597	43005682-220
221	1.421	0.012	0.139	0.004	1.699	1.684	1.687	1.465	1.437	1.440	1.659	43005682-221 43005682-222
222	1.484	0.015	0.139	0.004	1.762	1.747	1.750	1.528	1.500	1.503	1.722	43005682-222
223	1.609	0.015	0.139	0.004	1.887	1.872	1.875	1.653	1.625	1.628	1.847	43005682-223
224	1.734	0.015	0.139	0.004	2.012	1.997	2.000	1.778	1.750	1.753	1.972	43005682-224
225	1.859	0.015	0.139	0.004	2.137	2.122	2.125	1.903	1.875	1.878	2.097	43005682-225
226	1.984	0.018	0.139	0.004	2.262	2.247	2.250	2.028	2.000	2.003	2.222	43005682-226
227	2.109	0.018	0.139	0.004	2.387	2.372	2.375	2.153	2.125	2.128	2.347	43005682-227
228	2.234	0.020	0.139	0.004	2.512	2.497	2.500	2.278	2.250	2.253	2.472	43005682-228
229	2.359	0.020	0.139	0.004	2.637	2.622	2.625	2.403	2.375	2.378	2.597	43005682-229
230	2.484	0.020	0.139	0.004	2.762	2.747	2.750	2.528	2.500	2.503	2.722	43005682-230
231	2.609	0.020	0.139	0.004	2.887	2.872	2.875	2.653	2.625	2.628	2.847	43005682-231
232	2.734	0.024	0.139	0.004	3.012	2.997	3.000	2.778	2.75	2.753	2.972	43005682-232
233	2.859	0.024	0.139	0.004	3.137	3.122	3.125	2.903	2.875	2.878	3.097	43005682-233
234	2.984	0.024	0.139	0.004	3.262	3.247	3.250	3.028	3.000	3.003	3.222	43005682-234
235	3.109	0.024	0.139	0.004	3.387	3.372	3.375	3.153	3.125	3.128 3.253	3.347	43005682-235
236	3.234	0.024	0.139	0.004	3.512	3.497	3.500	3.278	3.250	3.253	3.472	43005682-236
237	3.359	0.024	0.139	0.004	3.637	3.622	3.625	3.403	3.375	3.378	3.597	43005682-237
238	3.484	0.024	0.139	0.004	3.762	3.747	3.750	3.528	3.500	3.503	3.722	43005682-238
239	3.609	0.028	0.139	0.004	3.887	3.872	3.875	3.653	3.625	3.628	3.847	43005682-239
240	3.734	0.028	0.139	0.004	4.012	3.997	4.000	3.778	3.750	3.753	3.972	43005682-240
242	3.984	0.028	0.139	0.004	4.262	4.247	4.250	4.028	4.000	4.003	4.222	43005682-242
243	4.109	0.028	0.139	0.004	4.387	4.372	4.375	4.153	4.125	4.128	4.347	43005682-243
244	4.234	0.030	0.139	0.004	4.512	4.497	4.500	4.278	4.250	4.253	4.472	43005682-244
245	4.359	0.030	0.139	0.004	4.637	4.622	4.625	4.403	4.375	4.378	4.597	43005682-245
246	4.484	0.030	0.139	0.004	4.762	4.747	4.750	4.528	4.500	4.503	4.722	43005682-246
247	4.609	0.030	0.139	0.004	4.887	4.872	4.875	4.653	4.625	4.628	4.847	43005682-247
248	4.734	0.030	0.139	0.004	5.012	4.997	5.000	4.778	4.750	4.753	4.972	43005682-248

Piston O.D.s shown in the darker-shaded areas may over stretch the O-ring. If so, select a material with greater elongation or use a two-piece piston.



568 Profile

GLAND DIMENSIONS — 568 Static O-ring — Inch (Cont'd)

O-ring 2-Size AS568	Seal Dimensions					Piston / Rod Hardware Dimensions						Part Number
	Inside Dia.	±	Width	±	Mean O.D. (Ref)	Piston			Rod			
						A Piston Dia. +.000/- .001	B Bore Dia. +.002/- .000	C Groove Dia. +.000/- .004	D Rod Dia. +.000/- .002	E Throat Dia. +.001/- .000	F Groove Dia. +.004/- .000	
250	4.984	0.035	0.139	0.004	5.262	5.247	5.250	5.028	5.000	5.003	5.222	43005682-250
251	5.109	0.035	0.139	0.004	5.387	5.372	5.375	5.153	5.125	5.128	5.347	43005682-251
254	5.484	0.035	0.139	0.004	5.762	5.747	5.750	5.528	5.500	5.503	5.722	43005682-254
255	5.609	0.035	0.139	0.004	5.887	5.872	5.875	5.653	5.625	5.628	5.847	43005682-255
258	5.984	0.035	0.139	0.004	6.262	6.247	6.250	6.028	6.000	6.003	6.222	43005682-258
259	6.234	0.040	0.139	0.004	6.512	6.497	6.500	6.278	6.250	6.253	6.472	43005682-259
260	6.484	0.040	0.139	0.004	6.762	6.747	6.750	6.528	6.500	6.503	6.722	43005682-260
264	7.484	0.045	0.139	0.004	7.762	7.747	7.750	7.528	7.500	7.503	7.722	43005682-264
316	0.850	0.010	0.210	0.005	1.270	1.247	1.250	0.910	0.875	0.878	1.215	43005682-316
321	1.162	0.012	0.210	0.005	1.582	1.559	1.562	1.222	1.187	1.190	1.527	43005682-321
323	1.287	0.012	0.210	0.005	1.707	1.684	1.687	1.347	1.312	1.315	1.652	43005682-323
324	1.350	0.012	0.210	0.005	1.770	1.747	1.750	1.410	1.375	1.378	1.715	43005682-324
325	1.475	0.015	0.210	0.005	1.895	1.872	1.875	1.535	1.500	1.503	1.840	43005682-325
326	1.600	0.015	0.210	0.005	2.020	1.997	2.000	1.660	1.625	1.628	1.965	43005682-326
327	1.725	0.015	0.210	0.005	2.145	2.122	2.125	1.785	1.750	1.753	2.090	43005682-327
328	1.850	0.015	0.210	0.005	2.270	2.247	2.250	1.910	1.875	1.878	2.215	43005682-328
329	1.975	0.018	0.210	0.005	2.395	2.372	2.375	2.035	2.000	2.003	2.340	43005682-329
337	1.975	0.024	0.210	0.005	3.395	3.372	3.375	3.035	3.000	3.003	3.340	43005682-337
358	5.60	0.037	0.210	0.005	6.020	5.997	6.000	5.660	5.625	5.628	5.965	43005682-358
425	4.475	0.033	0.275	0.006	5.025	4.996	5.000	4.548	4.500	4.504	4.952	43005682-425
O-ring 2-Size AS5202 & J1926 Bosses	Seal Dimensions					Piston / Rod Hardware Dimensions						Part Number
Inside Dia.	±	Width	±	Mean O.D. (Ref)	Refer to external specs AS5202 & SAE J1926 for boss seal hardware dimensions							
904	0.351	0.005	0.072	0.003	0.495	Refer to external specs AS5202 & SAE J1926 for boss seal hardware dimensions						43005683-904
905	0.414	0.005	0.072	0.003	0.558	Refer to external specs AS5202 & SAE J1926 for boss seal hardware dimensions						43005683-905
906	0.468	0.005	0.078	0.003	0.624	Refer to external specs AS5202 & SAE J1926 for boss seal hardware dimensions						43005683-906
908	0.644	0.009	0.087	0.003	0.818	Refer to external specs AS5202 & SAE J1926 for boss seal hardware dimensions						43005683-908
910	0.755	0.009	0.097	0.003	0.949	Refer to external specs AS5202 & SAE J1926 for boss seal hardware dimensions						43005683-910
912	0.924	0.009	0.116	0.004	1.156	Refer to external specs AS5202 & SAE J1926 for boss seal hardware dimensions						43005683-912
916	1.171	0.010	0.119	0.004	1.409	Refer to external specs AS5202 & SAE J1926 for boss seal hardware dimensions						43005683-916

Piston O.D.s shown in the darker-shaded areas may over stretch the O-ring. If so, select a material with greater elongation or use a two-piece piston.



DG Profile, Resilon® Polyurethane D-ring

Parker's DG Profile Resilon® polyurethane D-ring is a problem solver featuring a variety of design advantages. The molded "D" shape, which is higher in the middle and lower on the ends, provides sealing in critical areas while reducing the chance of a seal being cut during installation. Its sealing lip contact footprint is minimized, thus reducing the amount of friction between seal and bore while providing expected sealing performance. The "D" shape is symmetrical so there is no performance degradation as the valve cycles in the reverse direction nor concern of backward installation of the seal. The design also incorporates "pressure pedestals" to eliminate the potential for "blow-by," common in reverse cycling.

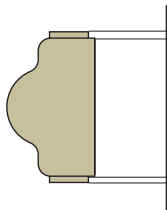

DG Profile Cross Section

RANGE OF APPLICATION

Standard Material	Temperature	Pressure	Speed
P4300A90	-65°F to +275°F (-54°C to +135°C)	5000 psi (344 bar)	< 1.6 ft/s (0.5 m/s)
Additional Material			
P4301A90	-35°F to +225°F (-37°C to +107°C)	5000 psi (344 bar)	< 1.6 ft/s (0.5 m/s)

- Premium, compression-set resistant Resilon® material
- Minimized contact footprint
- Excellent sealing performance
- Extrusion resistant material
- Eliminates need for back-ups
- Easy, mistake-proof/damage-free installation
- Pressure pedestals eliminate "blow-by"
- Fit industrial O-ring grooves
- Eliminates spiral failure



DG installed in Gland



DG Profile

PART NUMBER NOMENCLATURE DG Profile — Inch

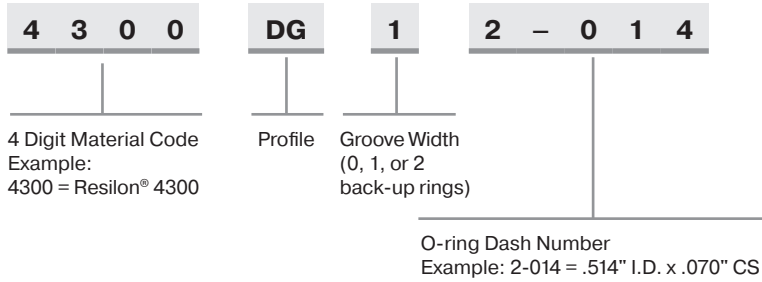

GLAND DIMENSIONS — DG Profile

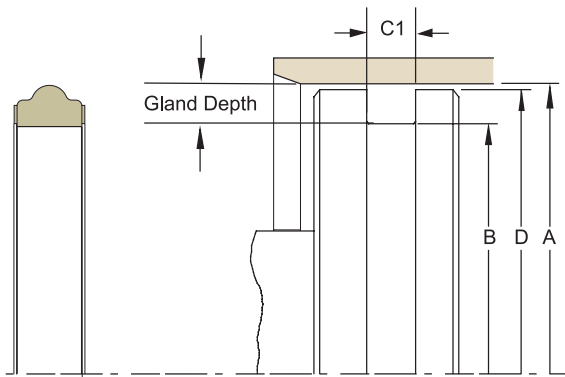

Please refer to the [Engineering Section](#) for surface finish and additional hardware considerations.

GLAND DIMENSIONS — DG Profile — Inch

O-ring 2-Size AS568A	A Bore Diameter		B Groove Diameter		C1 Groove Width One Back-up	D Piston Diameter		Part Number
	Dia.	Tol.	Dia.	Tol.	+ .005 / - .000	Dia.	Tol.	
010	0.374	+ .002 / - .000	0.264	+ .000 / - .002	0.138	0.372	+ .000 / - .001	4300DG12-010
011	0.436	+ .002 / - .000	0.326	+ .000 / - .002	0.138	0.434	+ .000 / - .001	4300DG12-011
012	0.499	+ .002 / - .000	0.389	+ .000 / - .002	0.138	0.497	+ .000 / - .001	4300DG12-012
013	0.561	+ .002 / - .000	0.451	+ .000 / - .002	0.138	0.559	+ .000 / - .001	4300DG12-013
014	0.624	+ .002 / - .000	0.514	+ .000 / - .002	0.138	0.622	+ .000 / - .001	4300DG12-014
015	0.686	+ .002 / - .000	0.576	+ .000 / - .002	0.138	0.684	+ .000 / - .001	4300DG12-015
016	0.749	+ .002 / - .000	0.639	+ .000 / - .002	0.138	0.747	+ .000 / - .001	4300DG12-016
017	0.811	+ .002 / - .000	0.701	+ .000 / - .002	0.138	0.809	+ .000 / - .001	4300DG12-017
018	0.874	+ .002 / - .000	0.764	+ .000 / - .002	0.138	0.872	+ .000 / - .001	4300DG12-018
019	0.936	+ .002 / - .000	0.826	+ .000 / - .002	0.138	0.934	+ .000 / - .001	4300DG12-019
020	0.999	+ .002 / - .000	0.889	+ .000 / - .002	0.138	0.997	+ .000 / - .001	4300DG12-020



The items described in this document are hereby offered for sale by Parker Hannifin Corporation, its subsidiaries or its authorized distributors. This offer and its acceptance are governed by the provisions in the “Offer of Sale.”

1. DEFINITIONS. As used herein, the following terms have the meanings indicated.

Buyer: means any customer receiving a Quote for Products.

Goods: means any tangible part, system or component to be supplied by Seller.

Products: means the Goods, Services and/or Software as described in a Quote.

Quote: means the offer or proposal made by Seller to Buyer for the supply of Products.

Seller: means Parker-Hannifin Corporation, including all divisions and businesses thereof.

Services: means any services to be provided by Seller

Software: means any software related to the Goods, whether embedded or separately downloaded.

Terms: means the terms and conditions of this Offer of Sale.

2. TERMS. All sales of Products by Seller are expressly conditioned upon, and will be governed by the acceptance of, these Terms. These Terms are incorporated into any Quote provided by Seller to Buyer. Buyer’s order for any Products whether communicated to Seller verbally, in writing, by electronic data interface or other electronic commerce, shall constitute acceptance of these Terms. Seller objects to any contrary or additional terms or conditions of Buyer. Reference in Seller’s order acknowledgement to Buyer’s purchase order or purchase order number shall in no way constitute an acceptance of any of Buyer’s terms or conditions of purchase. No modification to these Terms will be binding on Seller unless agreed to in writing and signed by an authorized representative of Seller.

3. PRICE; PAYMENT. The Products set forth in the Quote are offered for sale at the prices indicated in the Quote. Unless otherwise specifically stated in the Quote, prices are valid for thirty (30) days and do not include any sales, use, or other taxes or duties. Seller reserves the right to modify prices at any time to adjust for any raw material price fluctuations. Unless otherwise specified by Seller, all prices are F.C.A. Seller’s facility (INCOTERMS 2020). All sales are contingent upon credit approval and full payment for all purchases is due thirty (30) days from the date of invoice (or such date as may be specified in the Quote). Unpaid invoices beyond the specified payment date incur interest at the rate of 1.5% per month or the maximum allowable rate under applicable law.

4. SHIPMENT; DELIVERY; TITLE AND RISK OF LOSS. All delivery dates are approximate, and Seller is not responsible for damages resulting from any delay. Regardless of the manner of shipment, delivery occurs and title and risk of loss or damage pass to Buyer, upon placement of the Products with the carrier at Seller’s facility. Unless otherwise agreed prior to shipment and for domestic delivery locations only, Seller will select and arrange, at Buyer’s sole expense, the carrier and means of delivery. When Seller selects and arranges the carrier and means of delivery, freight and insurance costs for shipment to the designated delivery location will be prepaid by Seller

and added as a separate line item to the invoice. Buyer shall be responsible for any additional shipping charges incurred by Seller due to Buyer’s acts or omissions. Buyer shall not return or repackage any Products without the prior written authorization from Seller, and any return shall be at the sole cost and expense of Buyer.

5. WARRANTY. The warranty for the Products is as follows: (i) Goods are warranted against defects in material or workmanship for a period of twelve (12) months from the date of delivery or 2,000 hours of use, whichever occurs first; (ii) Services shall be performed in accordance with generally accepted practices and using the degree of care and skill that is ordinarily exercised and customary in the field to which the Services pertain and are warranted for a period of six (6) months from the date of completion of the Services; and (iii) Software is only warranted to perform in accordance with applicable specifications provided by Seller to Buyer for ninety (90) days from the date of delivery or, when downloaded by a Buyer or end-user, from the date of the initial download. All prices are based upon the exclusive limited warranty stated above, and upon the following disclaimer: EXEMPTION CLAUSE; DISCLAIMER OF WARRANTY, CONDITIONS, REPRESENTATIONS: THIS WARRANTY IS THE SOLE AND ENTIRE WARRANTY, CONDITION, AND REPRESENTATION, PERTAINING TO PRODUCTS. SELLER DISCLAIMS ALL OTHER WARRANTIES, CONDITIONS, AND REPRESENTATIONS, WHETHER STATUTORY, EXPRESS OR IMPLIED, INCLUDING BUT NOT LIMITED TO THOSE RELATING TO DESIGN, NONINFRINGEMENT, MERCHANTABILITY, AND FITNESS FOR A PARTICULAR PURPOSE. SELLER DOES NOT WARRANT THAT THE SOFTWARE IS ERROR-FREE OR FAULT-TOLERANT, OR THAT BUYER’S USE THEREOF WILL BE SECURE OR UNINTERRUPTED. UNLESS OTHERWISE AUTHORIZED IN WRITING BY SELLER, THE SOFTWARE SHALL NOT BE USED IN CONNECTION WITH HAZARDOUS OR HIGH RISK ACTIVITIES OR ENVIRONMENTS. EXCEPT AS EXPRESSLY STATED HEREIN, ALL PRODUCTS ARE PROVIDED “AS IS”.

6. CLAIMS; COMMENCEMENT OF ACTIONS. Buyer shall promptly inspect all Products upon receipt. No claims for shortages will be allowed unless reported to Seller within ten (10) days of delivery. Buyer shall notify Seller of any alleged breach of warranty within thirty (30) days after the date the non-conformance is or should have been discovered by Buyer. Any claim or action against Seller based upon breach of contract or any other theory, including tort, negligence, or otherwise must be commenced within twelve (12) months from the date of the alleged breach or other alleged event, without regard to the date of discovery.

7. LIMITATION OF LIABILITY. IN THE EVENT OF A BREACH OF WARRANTY, SELLER WILL, AT ITS OPTION, REPAIR OR REPLACE THE NON-CONFORMING PRODUCT, RE-PERFORM THE SERVICES, OR REFUND THE PURCHASE PRICE PAID WITHIN A REASONABLE PERIOD OF TIME. IN NO EVENT IS SELLER LIABLE FOR ANY SPECIAL, INDIRECT, INCIDENTAL OR CONSEQUENTIAL DAMAGES INCLUDING ANY LOSS OF REVENUE OR PROFITS, WHETHER BASED IN CONTRACT, TORT OR OTHER LEGAL



THEORY. IN NO EVENT SHALL SELLER'S LIABILITY UNDER ANY CLAIM MADE BY BUYER EXCEED THE PURCHASE PRICE PAID FOR THE PRODUCTS.

8. CONFIDENTIAL INFORMATION. Buyer acknowledges and agrees that any technical, commercial, or other confidential information of Seller, including, without limitation, pricing, technical drawings or prints and/or part lists, which has been or will be disclosed, delivered or made available, whether directly or indirectly, to Buyer ("Confidential Information"), has been and will be received in confidence and will remain the property of Seller. Buyer further agrees that it will not use Seller's Confidential Information for any purpose other than for the benefit of Seller.

9. LOSS TO BUYER'S PROPERTY. Any tools, patterns, materials, equipment or information furnished by Buyer or which are or become Buyer's property ("Buyer's Property"), will be considered obsolete and may be destroyed by Seller after two (2) consecutive years have elapsed without Buyer ordering the Products manufactured using Buyer's Property. Furthermore, Seller shall not be responsible for any loss or damage to Buyer's Property while it is in Seller's possession or control.

10. SPECIAL TOOLING. "Special Tooling" includes but is not limited to tools, jigs, fixtures and associated manufacturing equipment acquired or necessary to manufacture Goods. Seller may impose a tooling charge for any Special Tooling. Such Special Tooling shall be and remain Seller's property notwithstanding payment of any charges by Buyer. In no event will Buyer acquire any interest in the Special Tooling, even if such Special Tooling has been specially converted or adapted for manufacture of Goods for Buyer and notwithstanding any charges paid by Buyer. Unless otherwise agreed, Seller has the right to alter, discard or otherwise dispose of any Special Tooling or other property owned by Seller in its sole discretion at any time.

11. SECURITY INTEREST. To secure payment of all sums due from Buyer, Seller retains a security interest in all Products delivered to Buyer and, Buyer's acceptance of these Terms is deemed to be a Security Agreement under the Uniform Commercial Code. Buyer authorizes Seller as its attorney to execute and file on Buyer's behalf all documents Seller deems necessary to perfect Seller's security interest.

12. USER RESPONSIBILITY. Buyer, through its own analysis and testing, is solely responsible for making the final selection of the Products and assuring that all performance, endurance, maintenance, safety and warning requirements of the application of the Products are met. Buyer must analyze all aspects of the application and follow applicable industry standards, specifications, and any technical information provided with the Quote or the Products, such as Seller's instructions, guides and specifications. If Seller provides options of or for Products based upon data or specifications provided by Buyer, Buyer is responsible for determining that such data and specifications are suitable and sufficient for all applications and reasonably foreseeable uses of the Products. In the event Buyer is not the end-user of the Products, Buyer will ensure such end-user complies with this paragraph.

13. USE OF PRODUCTS, INDEMNITY BY BUYER. Buyer shall comply with all instructions, guides and specifications provided by Seller with the Quote or the Products. Unauthorized Uses. If Buyer uses or resells the Products in any way prohibited by Seller's instructions, guides or specifications, or Buyer otherwise fails to comply with Seller's instructions, guides and specifications, Buyer acknowledges that any such use, resale, or non-compliance is at Buyer's sole risk. Further, Buyer shall indemnify, defend, and hold Seller harmless from any losses, claims, liabilities, damages, lawsuits, judgments and costs (including attorney fees and defense costs), whether for personal injury, property damage, intellectual property infringement or any other claim, arising out of or in connection with: (a) improper selection, design, specification, application, or any misuse of Products; (b) any act or omission, negligent or otherwise, of Buyer; (c) Seller's use of patterns, tools, equipment, plans, drawings, designs, specifications or other information or things furnished by Buyer; (d) damage to the Products from an external cause, repair or attempted repair by anyone other than Seller, failure to follow instructions, guides and specifications provided by Seller, use with goods not provided by Seller, or opening, modifying, deconstructing, tampering with or repackaging the Products; or (e) Buyer's failure to comply with these Terms. Seller shall not indemnify Buyer under any circumstance except as otherwise provided in these Terms.

14. CANCELLATIONS AND CHANGES. Buyer may not cancel or modify, including but not limited to movement of delivery dates for the Products, any order for any reason except with Seller's written consent and upon terms that will indemnify, defend and hold Seller harmless against all direct, incidental and consequential loss or damage and any additional expense. Seller, at any time, may change features, specifications, designs and availability of Products.

15. LIMITATION ON ASSIGNMENT. Buyer may not assign its rights or obligations without the prior written consent of Seller.

16. FORCE MAJEURE. Seller is not liable for delay or failure to perform any of its obligations by reason of events or circumstances beyond its reasonable control. Such circumstances include without limitation: accidents, labor disputes or stoppages, government acts or orders, acts of nature, pandemics, epidemics, other widespread illness, or public health emergency, delays or failures in delivery from carriers or suppliers, shortages of materials, war (whether declared or not) or the serious threat of same, riots, rebellions, acts of terrorism, fire or any reason whether similar to the foregoing or otherwise. Seller will resume performance as soon as practicable after the event of force majeure has been removed. All delivery dates affected by force majeure shall be tolled for the duration of such force majeure and rescheduled for mutually agreed dates as soon as practicable after the force majeure condition ceases to exist. Force majeure shall not include financial distress, insolvency, bankruptcy, or other similar conditions affecting one of the parties, affiliates and/or sub-contractors.

17. WAIVER AND SEVERABILITY. Failure to enforce any provision of these Terms will not invalidate that provision; nor will any such failure prejudice either party's right to enforce that provision in the future. Invalidation of any provision of these Terms shall not invalidate any other provision herein and, the remaining provisions will remain in full force and effect.



18. TERMINATION. Seller may terminate any agreement governed by or arising from these Terms for any reason and at any time by giving Buyer thirty (30) days prior written notice. Seller may immediately terminate, in writing, if Buyer: (a) breaches any provision of these Terms, (b) becomes or is deemed insolvent, (c) appoints or has appointed a trustee, receiver or custodian for all or any part of Buyer's property, (d) files a petition for relief in bankruptcy on its own behalf, or one is filed against Buyer by a third party, (e) makes an assignment for the benefit of creditors; or (f) dissolves its business or liquidates all or a majority of its assets.

19. OWNERSHIP OF SOFTWARE. Seller retains ownership of all Software supplied to Buyer hereunder. In no event shall Buyer obtain any greater right in and to the Software than a right in the nature of a license limited to the use thereof and subject to compliance with any other terms provided with the Software.

20. INDEMNITY FOR INFRINGEMENT OF INTELLECTUAL PROPERTY RIGHTS. Seller is not liable for infringement of any patents, trademarks, copyrights, trade dress, trade secrets or similar rights ("Intellectual Property Rights") except as provided in this Section. Seller will defend at its expense and will pay the cost of any settlement or damages awarded in an action brought against Buyer based on a third party claim that one or more of the Products sold hereunder infringes the Intellectual Property Rights of a third party in the country of delivery of the Products by Seller to Buyer. Seller's obligation to defend and indemnify Buyer is contingent on Buyer notifying Seller within ten (10) days after Buyer becomes aware of any such claim, and Seller having sole control over the defense of the claim including all negotiations for settlement or compromise. If one or more Products sold hereunder is subject to such a claim, Seller may, at its sole expense and option, procure for Buyer the right to continue using the Products, replace or modify the Products so as to render them non-infringing, or offer to accept return of the Products and refund the purchase price less a reasonable allowance for depreciation. Seller has no obligation or liability for any claim of infringement: (i) arising from information provided by Buyer; or (ii) directed to any Products provided hereunder for which the designs are specified in whole or part by Buyer; or (iii) resulting from the modification, combination or use in a system of any Products provided hereunder. The foregoing provisions of this Section constitute Seller's sole and exclusive liability and Buyer's sole and exclusive remedy for claims of infringement of Intellectual Property Rights.

21. GOVERNING LAW. These Terms and the sale and delivery of all Products are deemed to have taken place in, and shall be governed

and construed in accordance with, the laws of the State of Ohio, as applicable to contracts executed and wholly performed therein and without regard to conflicts of laws principles. Buyer irrevocably agrees and consents to the exclusive jurisdiction and venue of the courts of Cuyahoga County, Ohio with respect to any dispute, controversy or claim arising out of or relating to the sale and delivery of the Products.

22. ENTIRE AGREEMENT. These Terms, along with the terms set forth in the main body of any Quote, forms the entire agreement between the Buyer and Seller and constitutes the final, complete and exclusive expression of the terms of sale and purchase. In the event of a conflict between any term set forth in the main body of a Quote and these Terms, the terms set forth in the main body of the Quote shall prevail. All prior or contemporaneous written or oral agreements or negotiations with respect to the subject matter shall have no effect. These Terms may not be modified unless in writing and signed by an authorized representative of Seller.

23. COMPLIANCE WITH LAWS. Buyer agrees to comply with all applicable laws, regulations, and industry and professional standards, including those of the United States of America, and the country or countries in which Buyer may operate, including without limitation the U.S. Foreign Corrupt Practices Act ("FCPA"), the U.S. Anti-Kickback Act ("Anti-Kickback Act"), U.S. and E.U. export control and sanctions laws ("Export Laws"), the U.S. Food Drug and Cosmetic Act ("FDCA"), and the rules and regulations promulgated by the U.S. Food and Drug Administration ("FDA"), each as currently amended. Buyer agrees to indemnify, defend, and hold harmless Seller from the consequences of any violation of such laws, regulations and standards by Buyer, its employees or agents. Buyer acknowledges that it is familiar with all applicable provisions of the FCPA, the Anti-Kickback Act, Export Laws, the FDCA and the FDA and certifies that Buyer will adhere to the requirements thereof and not take any action that would make Seller violate such requirements. Buyer represents and agrees that Buyer will not make any payment or give anything of value, directly or indirectly, to any governmental official, foreign political party or official thereof, candidate for foreign political office, or commercial entity or person, for any improper purpose, including the purpose of influencing such person to purchase Products or otherwise benefit the business of Seller. Buyer further represents and agrees that it will not receive, use, service, transfer or ship any Products from Seller in a manner or for a purpose that violates Export Laws or would cause Seller to be in violation of Export Laws. Buyer agrees to promptly and reliably provide Seller all requested information or documents, including end-user statements and other written assurances, concerning Buyer's ongoing compliance with Export Laws.

Care is taken in the preparation of this publication; however Parker shall not be responsible for a user's reliance on any inadvertent typographical errors or omissions. Information in this catalog is only accurate as of the date of publication. For more current information, please consult the Parker EPS Division website at www.parker.com/eps.



 **WARNING**

FAILURE OR IMPROPER SELECTION OR IMPROPER USE OF THE PRODUCTS AND/OR SYSTEMS DESCRIBED HEREIN OR RELATED ITEMS CAN CAUSE DEATH, PERSONAL INJURY AND PROPERTY DAMAGE.

This document and other information from Parker Hannifin Corporation, its subsidiaries and authorized distributors provide product and/or system options for further investigation by users having expertise. It is important that you analyze all aspects of your application, including consequences of any failure and review the information concerning the product or system in the current product catalog. Due to the variety of operating conditions and applications for these products or systems, the user, through its own analysis and testing, is solely responsible for making the final selection of the products and systems and assuring that all performance, safety and warning requirements of the application are met.

The products described herein, including without limitation, product features, specifications, designs, availability and pricing, are subject to change by Parker Hannifin Corporation and its related companies at any time without notice.

